

User's Manual

Revision n. 15
20 March 2008

MOD. SY 1527
UNIVERSAL MULTICHANNEL
POWER SUPPLY SYSTEM
USER'S MANUAL REV.15

NPO:
00103/97:1527y.MUTx/15

CAEN will repair or replace any product within the guarantee period if the Guarantor declares that the product is defective due to workmanship or materials and has not been caused by mishandling, negligence on behalf of the User, accident or any abnormal conditions or operations.

CAEN declines all responsibility for damages or injuries caused by an improper use of the Modules due to negligence on behalf of the User. It is strongly recommended to read thoroughly the CAEN User's Manual before any kind of operation.



CAEN reserves the right to change partially or entirely the contents of this Manual at any time and without giving any notice.

Disposal of the Product

The product must never be dumped in the Municipal Waste. Please check your local regulations for disposal of electronics products.



TABLE OF CONTENTS

1. ABOUT THIS MANUAL	8
1.1 ORGANISATION	9
1.2 CONVENTIONS	10
1.2.1 Safety rules	10
1.2.2 Electrical signal specifications.....	10
2. GENERAL DESCRIPTION OF THE SYSTEM	11
2.1 OVERVIEW	11
2.2 SY1527 FUNCTIONAL DESCRIPTION	12
2.3 TECHNICAL SPECIFICATION TABLES.....	16
2.4 SY1527LC SHORT FUNCTIONAL DESCRIPTION	19
3. SAFETY INFORMATION AND OPERATION REQUIREMENTS	21
3.1 GENERAL INFORMATION.....	21
3.1.1 Injury Precautions.....	21
3.1.2 Product Damage Precautions	21
3.1.3 EC Certifications and Compliance.....	22
3.1.4 Terms in this Manual.....	22
3.2 SAFETY TERMS AND SYMBOLS ON THE PRODUCT	22
3.3 GENERAL OPERATION REQUIREMENTS	22
3.4 POWER CORDS	22
4. SYSTEM AND CHANNEL CONTROL.....	24
4.1 INTRODUCTION.....	24
4.2 SYSTEM CONTROL	24
4.2.1 NIM / TTL standard selection.....	25
4.2.2 LOCAL/REMOTE Power-On	25
4.2.3 LOCAL/REMOTE Channel Enable	25
4.2.4 VSEL command	26
4.2.5 ISEL command	26
4.2.6 KILL command.....	26
4.2.7 RESET command.....	26
4.2.8 INTERLOCK command.....	27
4.2.9 HV SYNC	28
4.3 SYSTEM STATUS MONITORING	28
4.3.1 Over Current	28
4.3.2 Under Voltage	29
4.3.3 Over Voltage.....	29
4.3.4 Trip	29
4.3.5 Reset flag	29
4.3.6 Check passed	29
4.3.7 GEN.....	30
4.3.8 CH-ON.....	30
4.3.9 Over Temperature	30
4.3.10 Fan Failure.....	30
4.3.11 Pwr Failure	30
4.4 CHANNEL PARAMETERS	31
4.4.1 CHANNEL NUMBER (CH #).....	31

4.4.2	CHANNEL NAME (CHANNEL).....	32
4.4.3	VMAX HARDWARE (HVMAX).....	32
4.4.4	VMAX SOFTWARE (SVMAX).....	32
4.4.5	VOSET.....	32
4.4.6	IOSET.....	32
4.4.7	VISET.....	32
4.4.8	IISSET.....	33
4.4.9	RAMP-UP (RU _p).....	33
4.4.10	RAMP-DOWN (RD _{wn}).....	33
4.4.11	VMON.....	33
4.4.12	IMON.....	33
4.4.13	TRIP.....	33
4.4.14	POWER (PW).....	34
4.4.15	POWER-ON (PO _n).....	34
4.4.16	POWER-DOWN (PD _{wn}).....	35
4.5	CHANNEL STATUS.....	35
4.6	BOARD STATUS.....	35
5.	SYSTEM POWER-ON.....	36
5.1	PRELIMINARY CHECK.....	36
5.2	LOCAL POWER-ON.....	36
5.3	REMOTE POWER-ON.....	37
5.3.1	MAIN switch.....	37
6.	CONFIGURING THE INTERFACES.....	38
6.1	RS232 INTERFACE.....	38
6.2	ETHERNET INTERFACE (TCP/IP PROTOCOL).....	39
6.2.1	Configuring the SY 1527 System for network connection.....	39
6.2.2	Configuring the host PC.....	39
6.2.3	Verifying connection.....	40
6.3	H.S. CAENET INTERFACE.....	40
7.	OPERATING MODES.....	41
7.1	STANDALONE OPERATION.....	41
7.1.1	Local Control Devices.....	42
7.1.1.1	LCD screen.....	42
7.1.1.2	Keypad.....	42
7.1.1.3	Compact Switch.....	42
7.1.2	Software Version.....	43
7.1.3	Menu Structure.....	43
7.1.4	Welcome Window.....	45
7.1.5	Login Window.....	45
7.1.6	Start Up Window.....	46
7.1.7	The - Menu: About.....	47
7.1.8	The - Menu: Session.....	48
7.1.9	The MAIN Menu: Channels.....	49
7.1.9.1	Channel Status.....	52
7.1.9.2	Board Status.....	53
7.1.10	The MAIN Menu: Crate Map.....	53
7.1.11	The MAIN Menu: Connect.....	55
7.1.12	The MAIN Menu: Logout.....	55
7.1.13	The GROUPS Menu and relevant commands.....	55
7.1.14	The VIEW Menu and relevant commands.....	58
7.1.15	The UTILITY Menu: Kill.....	58
7.1.16	The UTILITY Menu: Clear Alarm.....	59

7.1.17	The UTILITY Menu: Status	60
7.1.18	The UTILITY Menu: Format	61
7.1.19	The UTILITY Menu: Board Upgrade	62
7.1.20	The UTILITY Menu: Remote Board Upgrade	64
7.1.21	The UTILITY Menu: System Upgrade	65
7.1.21.1	System Upgrade with PumpKIN by the KLEVER GROUP INC.	68
7.1.22	The SETUP Menu: Reset Flag	71
7.1.23	The SETUP Menu: Communications	72
7.1.24	The SETUP Menu: Security	73
7.1.25	The SETUP Menu: Tech Info	73
7.1.26	The SETUP Menu: HV Clock Conf.	74
7.1.27	The SETUP MENU: Advanced	75
7.1.27.1	Event Mode	76
7.2	REMOTE OPERATION VIA TERMINAL	76
7.2.1	Using the RS232 interface	77
7.2.2	Using the H.S. CAENET (Multirate Operation)	77
7.2.2.1	H.S. CAENET protocol	78
7.2.2.2	H.S. CAENET node address	78
7.2.2.3	H.S. CAENET network termination	78
7.2.2.4	H.S. CAENET multirate operation sequence	78
7.2.3	Using the TCP/IP protocol via Ethernet (Telnet Client)	79
7.3	REMOTE OPERATION VIA HOST COMPUTER	79
8.	TRIP HANDLING	81
8.1	INTERNAL TRIP	81
8.2	EXTERNAL TRIP	82
9.	SECURE ACCESS AND USER'S PROFILE MANAGEMENT	83
9.1	MULTILEVEL LOGIN PROFILE ENVIRONMENT	83
9.1.1	Guest profile	84
9.1.2	User profile	85
9.1.3	Administrator profile	85
APPENDIX A	86
SY1527 SYSTEM FRONT PANEL	87

LIST OF FIGURES

FIG. 2.1	– LAYOUT OF THE MAIN MECHANICAL SECTIONS OF THE SY1527 MAINFRAME	11
FIG. 2.2	– BLOCK DIAGRAM OF THE FUNCTIONAL PARTS OF THE SY1527 SYSTEM	15
FIG. 2.3	– FRONT PANEL OF THE SY1527LC SYSTEM	20
FIG. 4.1	– RESET TIMING	27
FIG. 4.2	– COMPLETE CHANNEL ADDRESS	31
FIG. 6.1	– RS232 CONNECTOR PIN ASSIGNMENT	38
FIG. 6.2	- THE RESULT OF A SUCCESSFUL "PING" TO THE SY 1527 SYSTEM	40
FIG. 7.1	– STANDALONE OPERATION	41
FIG. 7.2	– MENU STRUCTURE IN STANDALONE OPERATION	44
FIG. 7.3	– WELCOME SCREEN IN STANDALONE OPERATION	45
FIG. 7.4	– LOGIN WINDOW	46
FIG. 7.5	– START UP WINDOW	47

FIG. 7.6 – ABOUT WINDOW	48
FIG. 7.7 – SESSION WINDOW	49
FIG. 7.8 – CHANNELS WINDOW	50
FIG. 7.9 – CRATE MAP WINDOW	54
FIG. 7.10 – CONNECT WINDOW	55
FIG. 7.11 – ADD CHANNELS POP-UP WINDOW	56
FIG. 7.12 – REMOVE CHANNELS POP-UP WINDOW	57
FIG. 7.13 – GROUP MODE WINDOW	58
FIG. 7.14 – KILL POP-UP WINDOW	59
FIG. 7.15 – CLEAR ALARM POP-UP WINDOW	60
FIG. 7.16 – STATUS POP-UP WINDOW	61
FIG. 7.17 – FORMAT POP-UP WINDOW	62
FIG. 7.18 – BOARD UPGRADE POP-UP WINDOW	64
FIG. 7.19 – REMOTE BOARD UPGRADE POP-UP WINDOW	65
FIG. 7.20 – SYSTEM UPGRADE POP-UP WINDOW	67
FIG. 7.21 – PUMPKIN MENU WINDOW	68
FIG. 7.22 – PUMPKIN OPTIONS WINDOW	68
FIG. 7.23 – CONNECTION VIA HYPERTERMINAL	69
FIG. 7.24 – SYSTEM LOG IN	69
FIG. 7.25 – THE UTILITY MENU/1	69
FIG. 7.26 – THE UTILITY MENU/2	70
FIG. 7.27 – THE UTILITY MENU/3	70
FIG. 7.28 – PUMPKIN TRANSFER CONFIRMATION	70
FIG. 7.29 – RESET FLAG POP-UP WINDOW	72
FIG. 7.30 – TECH INFO POP-UP WINDOW	74
FIG. 7.31 – HV CLOCK CONF. WINDOW	74
FIG. 7.32 – ADVANCED MENU OPTIONS	75
FIG. 7.33 – EVENT MODE PASSWORD REQUEST	75
FIG. 7.34 – REMOTE OPERATION VIA TERMINAL	76
FIG. 7.35 – WELCOME SCREEN IN TERMINAL OPERATION	77
FIG. 7.36 – REMOTE OPERATION VIA HOST COMPUTER	80
FIG. 8.1 – TRIP BUS SCHEME	82

LIST OF TABLES

TABLE 2.1 – TECHNICAL SPECIFICATIONS OF THE SY1527 / SY1527LC MAINFRAME: GENERAL	16
TABLE 2.2 – TECHNICAL SPECIFICATIONS OF THE SY1527: FRONT AND REAR PANEL COMPONENTS	17
TABLE 2.3 – TECHNICAL SPECIFICATIONS OF THE SY1527 MAINFRAME: INPUT AND OUTPUT SIGNALS	18

TABLE 2.4 – TECHNICAL SPECIFICATIONS OF THE SY1527LC.....	20
TABLE 6.1 – RS232 PORT DEFAULT SETTINGS.....	38
TABLE 6.2 – TCP/IP PROTOCOL DEFAULT SETTINGS.....	39
TABLE 6.3 – AN EXAMPLE OF TCP/IP PROTOCOL SETTINGS	39
TABLE 6.4 – H.S. CAENET DEFAULT SETTINGS	40
TABLE 7.1 – LOCAL CONTROL COMMANDS AND EXTERNAL KEYBOARD COMMANDS.....	42
TABLE 9.1 – OPERATIONS ALLOWED IN A GUEST, USER AND ADMINISTRATOR LOGIN SESSION	84

1. About this manual

The purpose of this guide is to illustrate:

- the several parameters and commands available for the control and status monitoring of the SY1527 Universal Multichannel Power Supply System and of the board channels,
- the requirements and instructions for its correct operation in different hardware configurations,
- the *User Software Interface* used to control the system interactively.

The preliminary section of the guide starts with a short description of the SY1527 system with a summary of its main features and performances.

The core of the guide consists of two sections:

a reference section with a detailed description of the commands, alarms and parameters which allow for the control and monitoring of the system and of the board channels;
a second section which illustrates the operating modes of the SY1527 system for different hardware configurations for interactive control of the system, paying particular attention to the *User Software Interface* for Standalone and Terminal operation and to that for Remote operation via WEB Browser.

A detailed description of all hardware components and system installation instructions can be found in the *Hardware Installation Guide*.

1.1 Organisation

This guide is organised as follows:

Chapter 1 – About this manual: it shortly describes the objectives and organisation of this guide;

Chapter 2 – General description of the system: it contains an overview of the system and its main features, a very short functional description and some reference tables with a summary of the system technical specifications;

Chapter 3 – Safety information and operation requirements: it contains general safety rules and the requirements for a correct system operation;

Chapter 4 – System and channel control: this reference section contains the description of all commands, parameters and alarms to control and monitor the status of the system and of the board channels;

Chapter 5 – System Power-On: it contains the procedure for the power-on of the system together with a first check of its correct operation;

Chapter 6 – Configuring the interfaces: it contains the procedure for the correct software configuration of the interfaces for the system remote control;

Chapter 7 – Operating modes: this is the guide core which contains the instructions to operate the system in different hardware configurations: in particular, the *User Software Interface* used in standalone operation and in remote operation via terminal and that used in remote operation via Web Browser are fully described;

Chapter 8 – Trip handling: it contains further details about how to handle trip conditions;

Chapter 9 – Error handling: it contains further details about how to handle error conditions;

Chapter 10 – Secure access and user's profile management: this section has been conceived for system administrators in order to allow for secure management of the system.

Chapter 11 – System diagnostic procedures: a reference section containing some diagnostic procedures to test system correct operation;

Appendix A – Front Panel of the SY1527 system: a useful reference figure of the SY1527 Front Panel, including the Primary Power Supply and the Power Supply Units.

1.2 Conventions

The conventions adopted all through the manual are shortly listed in the following.

1.2.1 Safety rules

The user is requested to pay particular attention to the parts of the document containing the following terms:

WARNING:

Warning statements identify conditions or practices that could result in injury or loss of life.

CAUTION:

Caution statements identify conditions or practices that could result in damage to this product or other property.

Please pay particular attention to the grey areas where warning and caution statements are emphasised, as shown in the following examples:



1.2.2 Electrical signal specifications

The polarity of the electrical signals can be chosen via software by the user. As a consequence, in this guide it has been adopted the following convention:

TRUE: an electrical signal is indicated as TRUE when it is active.

FALSE: an electrical signal is indicated as FALSE when it is not active.

2. General description of the system

This preliminary section contains a short description of the SY1527 system with a summary of its features and some tables with its main technical specifications. A detailed description of technical specifications and hardware installation instructions can be found in the *Hardware Installation Guide*.

2.1 Overview

The SY1527 system is the fully equipped experiment version of a new line of power supply systems which represent CAEN's latest proposal in the matter of High Voltage and Low Voltage Power Supplying. This system outlines a completely new approach to power generation and distribution by allowing the housing, in the same mainframe, of a wide range of boards with different functions, such as High/Low Voltage boards, generic I/O boards (temperature, pressure monitors, etc.) and branch controllers, where the latter are used to control other remote generators and distributors.

Modularity, flexibility and reliability are the key-points of its design, enabling this module to meet the requirements needed in a wide range of experimental conditions. The latter range from those of LHC experiments, in which the features of this model find prior application, to those of other less challenging, but still demanding, High Energy Physics experiments.

The mainframe is housed in a 19"-wide, 8U-high euro-mechanics rack and hosts four main sections (refer to Fig. 2.1):

- the *Board Section*, with 16 slots to house boards, distributors and branch controllers;
- the *Fan Tray Section*, housing 6 fans disposed on two rows;
- the *Power Supply Section*, which consists of the primary power supply and up to 3 power supply units;
- the *CPU and Front Panel Section* which includes all interface facilities.

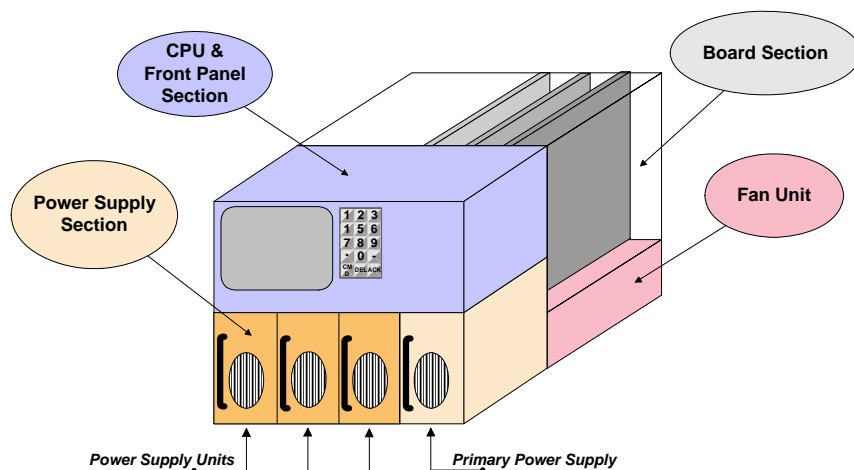

Fig. 2.1 – Layout of the main mechanical sections of the SY1527 mainframe

The User Software Interface features the usual friendliness of the previous CAEN systems which now also includes a 7.7" colour LCD. A wide choice of interface facilities provides full communication compatibility with the previous systems and the feasibility of controlling heterogeneous external devices.

The **SY1527LC** system is the "low cost" version of the CAEN fully equipped power supply SY1527 system: the SY1527LC shares all the features with the SY1527 but has no colour 7.7" LCD, compact switch, alphanumeric keypad and I/O Control section (see § 2.4).

Modularity has been one of the leading criteria in the design and development of the system: both the *Power Supply Section* and the *Board Section* are completely modular. The *Power Supply Section* allows different configurations with up to 3 power supply units per mainframe (up to 2250 W), while the *Board Section* can house up to 16 boards able to fulfil different functions.

A complete line of power supply boards and distributors, has been specially developed for this new system. The minimum system configuration consists of the primary power supply, one Power Supply Unit and one board.

The system allows also to deal with power supply solutions composed by "branch controllers" (housed in the system main frame) and on-detector "remote boards" (manufactured in order to be magnetic field and radiation tolerant).

Channel trip control on other crates is performed via four external differential trip lines. A sophisticated trip handling via software allows to control and correlate trip conditions on the channels of the crate as well as of other crates connected to it.

Live insertion and extraction of the boards, which reduces the down time of the global system, and easy access to the computing core and peripherals of the system completes the system flexibility.

Easy interfacing is another key-point of the SY1527 system, which can be connected to SY127 and SY527 systems.

The Ethernet interface (TCP/IP) allows both an easy Telnet access and the connection via OPC Server to a SCADA control system.

Enhanced software programming features a unified command set independent from the interface used to communicate with the system.

The Power Supply Section and Board Section can be externally synchronised via front panel connectors.

Multi-layered access to the system via Intranet is foreseen through the management of several custom user's profiles. In particular, three different access levels have been implemented: *Guest*, *User* and *Administrator*, each of which with password protection.

Handy maintenance and upgrading, which constitute a major issue in the reliability of a system, are further guaranteed by the possibility of accessing and servicing the system via network facilities. Actually, the Telnet access facility allow remote debugging and technical support of the system, including future firmware upgrading.

2.2 SY1527 Functional description

A block diagram of the SY1527 system is shown in Fig. 2.2, p.15.

A single crate can host up to 16 Channel Boards, which can be chosen in a wide range of plug-in boards, from standard HV/LV boards and floating boards to generic I/O boards

monitoring external parameters or branch controllers. All the types of boards can be freely mixed in the same crate so as to fit the user's needs.

Both the Power-On and the Channel Out Enable of the System can be performed either locally or remotely. Remote Enable is performed by sending the proper input signal via the relevant front panel connector.

Each crate may be controlled either locally or remotely. Local control is performed manually through a key-pad, a compact switch and a 7.7" colour LCD located on the front panel. Remote control is feasible via the interface connectors located on the front panel. These include a RS232 interface, which can be used to plug in a video terminal (ANSI VT100 or compatible) or a IBM™ PC, a VGA port to connect an external standard VGA monitor and a PS/2 connector to plug in an external keyboard. The usual HIGH SPEED (H.S.) CAENET interface is also available to daisy-chain more SY1527 crates (up to 99 crates), eventually mixed with SY127 or Sy527.

A sophisticated Software User Interface is available both in local or remote control, featuring symbolic names for channels, custom status displays and other features designed to help the management of a large number of channels.

Programmable parameters for each power channel include two voltage values (**V0set**, **V1set**) and two current limit values (**I0set**, **I1set**). The switching from one value to the other is performed via two external (NIM or TTL) input levels (VSEL, ISEL). The maximum rate of change of the voltage (Volt/second) may be programmed for each channel. Two distinct values are available, **Ramp-Up** and **Ramp-Down**. Any command to change the voltage will result in a linear voltage increase or decrease with time, the rates being determined by the Ramp-Up or Ramp-Down parameters, respectively.

For the *boards with programmable current hardware protections* the ISET values of the channels represent a software-controlled hardware protection on the channels' currents. In this case the channel cannot draw a current higher than its programmed limit.

For the *boards with fixed current hardware protections*, i.e. boards which have the current hardware protection fixed to a common value for all the channels, the IMON values are used to signal a fault, but the channels can draw a current larger than the ISET values.

In both cases, if a channel tries to draw a current larger than the programmed limit, it is signalled to be in OVERCURRENT. The System detects this state as a fault and reacts according to the setting of the **TRIP** parameter, namely:

1) *TRIP = infinite (constant CURRENT mode)*

If the Board has programmable current hardware protections, the output voltage is varied to keep the current below the programmed limit. The channel behaves like a current generator.

If the Board has fixed current hardware protections, the output current is permitted to exceed the ISET value; the channel behaves like a current generator only if the maximum current value is reached.

2) *TRIP = finite value (TRIP mode)*

In this case, the channel behaves as in the constant CURRENT mode for a time equal to the finite value set as TRIP parameter, and then it is switched off according to the selected Power-Down option (Kill/Ramp-Down). If the Kill option is selected, the channel will be switched off immediately. If the Ramp-Down option is selected, the voltage will drop to zero at a rate determined by the value of the Ramp-Down parameter programmed for that channel.

Other front panel signals and relevant LEDs are foreseen to signal the channel status, such as OVERVOLTAGE, UNDERVOLTAGE, CHANNEL ON and TRIP. Another set of LEDs warn about possible fault conditions in the system operation (OVER TEMPERATURE, FAN FAILURE, POWER FAILURE). For a detailed description of these conditions please refer to Section 4 in this manual. A description of all front panel components can be found in the *Hardware Installation Guide*.

A RESET can be generated either manually via a front panel button or remotely by sending a proper signal through the relevant connector. In both cases it is possible to reset only the CPU of the system or both the CPU and the boards, depending on the duration of the RESET signal. The System may be instructed to react to a Power On or to a Restart bringing all the channels from zero to the programmed value without the user's intervention via the **Power-On** parameter. If this option is enabled, the System will recover smoothly from a power failure or RESET, automatically restoring the status it had before the power was interrupted. KILL and INTERLOCK functions have been also implemented and allow to drop the channel output voltage to zero, independently from the Ramp-Down parameter set.

For a detailed description of all system control and monitoring signals and of channel parameters please refer to Section 4 in this manual.

In order to protect the System from improper use, a multilevel management of user's profiles has been foreseen, including the possibility of having password protection for each channel or group of channels. In particular, three different login levels are available: *Guest*, *User* and *Administrator*, each with different levels of access ability to the system parameter monitoring and setting. Moreover, the possibility of defining preferred custom environments is foreseen for each single user. Please refer to Section 9 for further details on this subject.

Daisy-chain configuration of more SY1527 crates can be achieved by using the H.S. CAENET connectors located on the front panel. The chain can be controlled remotely by a SY1527 system configured as CAENET Controller allowing for *Multicrate Operation*, i.e. the possibility of controlling and monitoring interactively the daisy-chained crates one at a time, either from any one of the SY1527 crates of the chain or from a PC or video terminal externally connected to any one of the crates. Moreover, in *Multicrate Operation* it is possible to connect to the chain a SY127 system, equipped with a A128HS board, and interact with it via H.S. CAENET. The same operation is also possible with a SY527 system.

The Ethernet interface further extends the access facilities to the system: it allows the use of a Telnet connection to monitor and control interactively each crate connected to the network. This type of link, which can be reduced to the Customer's Intranet in order to have secure access, allows to perform remotely a wide range of tasks, such as system debugging, firmware upgrading and even technical support. An OPC Server and a C language library (CAEN HV Wrapper) have been developed for the monitoring and setting of system parameters from TCP/IP environment.

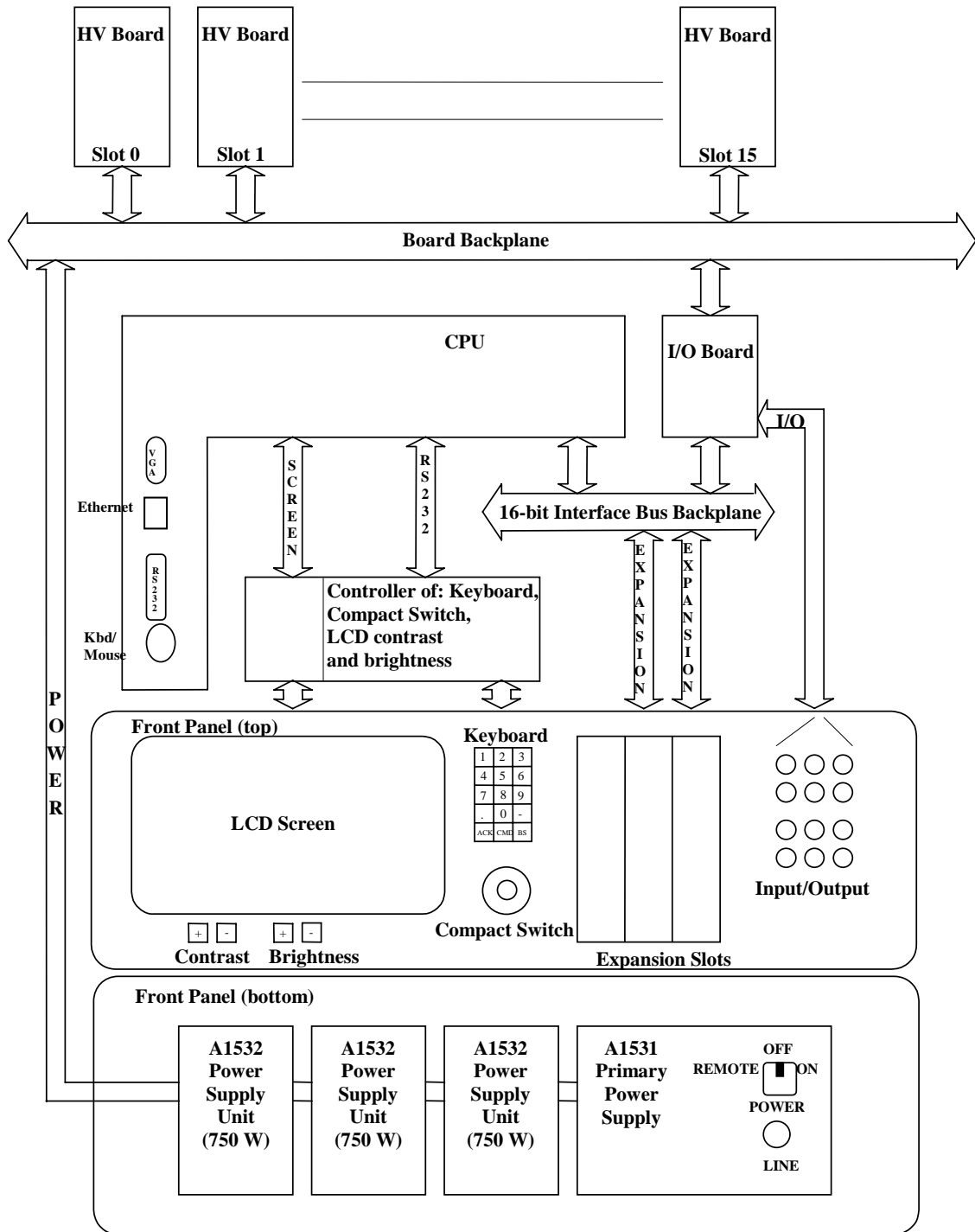

Fig. 2.2 – Block diagram of the functional parts of the SY1527 system

2.3 Technical specification tables

Table 2.1 – Technical specifications of the SY1527 / SY1527LC mainframe: general

Packaging	- 19"-wide, 8U-high Euro-mechanics rack; - Depth: 720 mm.
Weight	- Mainframe (*): 24 kg - Mod. A1532: 3.2 kg
Power Requirements	<i>Voltage range:</i> 100/230 V <i>Frequency:</i> 50/60 Hz <i>Power:</i> 3400 W
Max. number of boards per crate	16
Max. number of Power Supply Units per crate	3
Primary power supply output	+/-12 V, 8 A +5 V, 20 A
Power supply unit output	+48 V, 15.6 A
Max. output power	2250 W
Operating temperature	From 0°C (dry atmosphere) to +40°C
Storage temperature	From -20°C (dry atmosphere) to +50°C

(*) One Primary Power Supply (Mod.A1531) and one Power Supply Unit (Mod.A1532) are included; boards are not included.

Table 2.2 – Technical specifications of the SY1527: front and rear panel components

(refer to the figure in Appendix A)

<p>Displays (I/O control section)</p>	<ul style="list-style-type: none"> – GEN, red LED, lights up as GENERAL STATUS signal, corresponding to a logic combination (defined by the user) of OVC, UNV, OVV, TRIP, is TRUE; – CH-ON, red LED, lights up as at least one channel is ON; – OVC, UNV, TRIP, OVV, red LEDs, light up as at least one channel is in <i>Over Current, Under Voltage, Trip, Over Voltage</i> condition, respectively; – RSTFLAG, red LED, lights up after a RESET; – CHK PASS, green LED, lights up as the initial system check has been performed successfully and the system is ready. – VSEL, ISEL, green LEDs, light up as the relevant connectors for voltage and current selection, respectively, are TRUE; – KILL, green LED, lights up as the system is in KILL condition; – NIM, TTL, green LEDs, light up as the relevant standard is selected; – RESET, red/orange LED, lights up as a RESET occurs: it is initially red and then becomes orange, depending on the duration of the RESET signal; – LOCAL ENABLE, REM ENABLE, red LEDs, light up, respectively, as the <i>Local Enable</i> mode is selected and as the <i>Remote Enable</i> mode is selected and the proper REM EN signal is sent in; – OVERTEMP, FAN FAILURE, PWR FAILURE red LEDs, light up as the <i>Over Temperature, Fan Failure</i> and <i>Power Failure</i> condition, respectively, occurs; – INTERLOCK, red LED, lights up as the system is in INTERLOCK condition. – LOCAL NET, CAENET, red LEDs, light up as the relevant connectors are in activity; – MASTER, red LED, lights up as the HV SYNC clock is internally generated.
<p>Displays (Power Supplies)</p>	<ul style="list-style-type: none"> – OK, yellow LED, lights up as the system is turned on. – +5, +12, -12, +48, green LEDs, light up as the relevant power supply is present; – MAIN, orange LED, when alight, it warns that the system is connected to the mains and the MAIN switch on the rear panel is in position 1.
<p>Switches</p>	<ul style="list-style-type: none"> – NIM/TTL switch for the selection of the level standard of the output signals; – LOCAL ENABLE/DISABLE/REMOTE ENABLE switch, which allows, respectively, to enable the channels locally or to disable them or to allow their remote enable via the proper ENABLE input signal; – INTERLOCK CLOSED/OPEN switch to select if the INTERLOCK function is active when the contact is closed or open, respectively. – MAIN switch (rear panel) to power the Power Supply Section; – POWER ON key (front panel, primary power supply) to power on the system locally or to enable its remote power on.
<p>Buttons</p>	<p>RESET push button: if $T_{RESET} > T_{RCPU} = 100\div 200$ ms \rightarrow CPU is reset; if $T_{RESET} > T_{RCH} = T_{RCPU} + 900$ ms \rightarrow CPU, boards are reset and the channels are turned off. Reset must be enabled via software (RESET FLAG window, see § 7.1.22).</p>
<p>Local Control Interfaces</p>	<ul style="list-style-type: none"> – 7.7" colour LCD screen, with brightness and contrast control buttons; – 15-key keypad; – compact switch (4 directions + press action).
<p>Remote Control Interfaces</p>	<ul style="list-style-type: none"> – H.S. CAENET; – LOCAL NET (ONLY for connection to a SY3527; see § 7.1.26); – One PS/2 connector for external PC keyboard; – VGA-standard connector for external VGA monitor; – ETHERNET (TCP/IP); – RS232 interface for external VT100 or PC.

Table 2.3 – Technical specifications of the SY1527 mainframe: input and output signals

(refer to the figure in Appendix A)

INPUTS	VSEL:	Std. NIM/TTL; 00-type LEMO connector. <i>Function:</i> channel voltage selection.
	ISEL:	Std. NIM/TTL; 00-type LEMO connector. <i>Function:</i> channel current selection.
	RESET:	Std. NIM/TTL; 00-type LEMO connector. <i>Function:</i> RESET from the front panel. If the duration of the RESET signal is $> T_{RCPU}=100\div 200$ ms, the CPU is reset; if it is $> T_{RCH}= T_{RCPU} + 900$ ms, also the boards are reset and the channels are turned off. Reset must be enabled via software (RESET FLAG window, see § 7.1.22).
	KILL:	Std. NIM/TTL; 00-type LEMO connector. <i>Function:</i> KILL from the front panel: it turns all channels off.
	ENABLE:	Std. NIM/TTL; 00-type LEMO connector. <i>Function:</i> remote enable.
	INTERLOCK:	open/closed contact; 00-type LEMO connector. <i>Function:</i> INTERLOCK command: it turns all the channels off as it is open/closed, according to the position of the relevant switch.
	REMOTE IN:	+12V, 50mA max., electric. insulated;tol.: $-40\%\div +20\%$;00LEMO connector. <i>Function:</i> remote power-on of the system.
OUTPUTS	OVC:	Std. NIM/TTL (selectable); 00-type LEMO connector. <i>Function:</i> at least one channel is in <i>Over Current</i> .
	UNV:	Std. NIM/TTL (selectable); 00-type LEMO connector. <i>Function:</i> at least one channel is in <i>Under Voltage</i> .
	OVV:	Std. NIM/TTL (selectable); 00-type LEMO connector. <i>Function:</i> at least one channel is in <i>Over Voltage</i> .
	CH-ON:	Std. NIM/TTL (selectable); 00-type LEMO connector. <i>Function:</i> at least one channel is ON.
	RST FLAG:	Std. NIM/TTL (selectable); 00-type LEMO connector. <i>Function:</i> a RESET occurred according to user's settings (RESET FLAG window).
	CHK PASSED:	Std. NIM/TTL (selectable); 00-type LEMO connector. <i>Function:</i> initial system check successful and system ready.
	TRIP:	Std. NIM/TTL (selectable); 00-type LEMO connector. <i>Function:</i> at least one channel in <i>Trip</i> condition.
	GEN:	Std. NIM/TTL (selectable); 00-type LEMO connector. <i>Function:</i> GENERAL STATUS indication; corresponds to the logic combination (defined by the user) of OVC, UNV, OVV, TRIP.
	REMOTE OUT:	+12V level, refer. to the crate ground;tol.: $-20\%\div +20\%$;00LEMO connector. <i>Function:</i> remote power-on of the adjacent daisy-chained crate.
I/O	HVSYNC:	Bidirectional differential signal ; 2-pin LEMO connectors. <i>Function:</i> sync clock for the PWS Units ((RS485 Std., 1.25 MHz).
	LOCAL NET:	Bidirectional differential signal; 2-pin LEMO connector. <i>Function:</i> LOCAL bus ONLY for connection to a SY3527
	CAENET:	Bidirectional CAENET; 00-type LEMO connector. <i>Function:</i> H.S. CAENET interface.
	TRIP IN/OUT:	Bidirectional differential signal; 5x2-flat connectors. <i>Function:</i> external TRIP lines to handle TRIP conditions.

All the above signals, except for the REMOTE IN/OUT, are referred to a common ground (COMMON GROUND) and are galvanically insulated up to 150 V with respect to the ground of the crate (CRATE GROUND).

2.4 SY1527LC Short Functional description

The SY1527LC system is the "low cost" version of the CAEN fully equipped experiment power supply system SY1527. All the features of the SY1527 are included, except the colour 7.7" LCD, the compact switch, the alphanumeric keypad and the I/O Control section. This system allows to house, in the same mainframe, a wide range of boards with different functions, such as High/Low Voltage boards, and branch controllers, which are used to control other remote generators and distributors.

The mainframe is housed in a 19"-wide, 8U-high euro-mechanics rack and hosts four main sections:

- the Board Section, with 16 slots to house boards, distributors and branch controllers; the Fan Tray Section, housing 6 fans arranged on two rows;
- the Power Supply Section, which consists of the primary power supply and up to 3 power supply units;
- the CPU and Front Panel Section which includes all interface facilities.

The User Software Interface provides full communication compatibility with the previous systems and the feasibility of controlling heterogeneous external devices. Modularity has been one of the leading criteria in the design and development of the system: both the Power Supply Section and the Board Section are completely modular.

The Power Supply Section allows different configurations with up to 3 power supply units per mainframe (up to 2250 W), while the Board Section can house up to 16 boards able to fulfil different functions.

A complete line of power supply boards and distributors has been specially developed for this new system. The minimum system configuration consists of the primary power supply, one Power Supply Unit and one board.

The system allows also to deal with power supply solutions composed by "branch controllers" (housed in the system main frame) and on-detector "remote boards" (manufactured in order to be magnetic field and radiation tolerant).

Channel trip control on other crates is performed via four external differential trip lines. A sophisticated trip handling via software allows to control and correlate trip conditions on the channels of the crate as well as of other crates connected to it.

Live insertion and extraction of the boards, which reduces the down time of the global system, and easy access to the computing core and peripherals of the system complete the system flexibility.

Easy interfacing is another key-point of the SY1527LC system, which can be connected to SY127 and SY527 systems.

The Ethernet interface (TCP/IP) allows both an easy Telnet access and the connection via OPC Server to a SCADA control system. Enhanced software programming features a unified command set independent from the interface used to communicate with the system. Multi-layered access to the system via Intranet is foreseen through the management of several custom user profiles. In particular, three different access levels have been implemented: Guest, User and Administrator, each of which with password protection.

Handy maintenance and upgrading, which constitute a major issue in the reliability of a system, are furtherly guaranteed by the possibility of accessing and servicing the system via network facilities. Actually, the Telnet access facility allows remote debugging and technical support of the system, including future firmware upgrading.

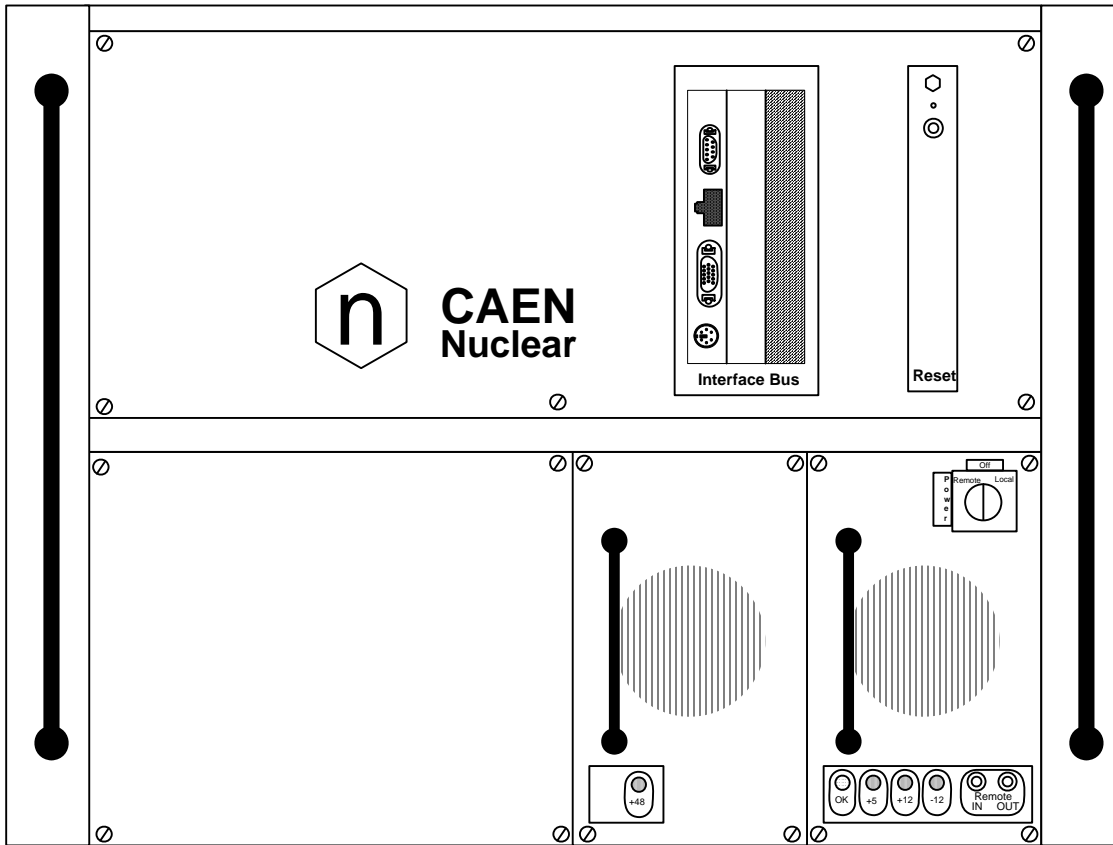

Fig. 2.3 – Front panel of the SY1527LC system

Table 2.4 – Technical specifications of the SY1527LC

Displays	<ul style="list-style-type: none"> – RESET, red/orange LED, lights up as a RESET occurs: it is initially red and then becomes orange, depending on the duration of the RESET signal; – OK, yellow LED, lights up as the system is turned on. – +5, +12, -12, +48, green LEDs, light up as the relevant power supply is present
Switches	<ul style="list-style-type: none"> – MAIN switch (rear panel) to power the Power Supply Section; – POWER ON key (front panel, primary power supply) to power on the system locally or to enable its remote power on.
Buttons	<p>RESET push button: if $T_{RESET} > T_{RCPU} = 100 \div 200 \text{ ms}$ → CPU is reset; if $T_{RESET} > T_{RCH} = T_{RCPU} + 900 \text{ ms}$ → CPU, boards are reset and the channels are turned off. Reset must be enabled via software (RESET FLAG window, see § 7.1.22).</p>
Remote Control Interfaces	<ul style="list-style-type: none"> – H.S. CAENET; – LOCAL NET (ONLY for connection to a SY3527; see § 7.1.26); – One PS/2 connector for external PC keyboard; – VGA-standard connector for external VGA monitor; – ETHERNET (TCP/IP); – RS232 interface for external VT100 or PC.

3. Safety information and operation requirements

This section contains the fundamental safety rules for the installation and operation of the SY1527 system.

Read thoroughly this section before starting any procedure of installation or operation of the product.

3.1 General information

Review the following safety precautions to avoid injury and prevent damage to this product or any products connected to it. To avoid potential hazards, use the product only as specified.

Only qualified personnel should perform service procedures.

3.1.1 Injury Precautions

Use Proper Power Cord and HV Cables.

To avoid fire hazard, use only the power cord and HV cables specified for this product.

Avoid Electric Overload.

To avoid electric shock or fire hazard, do not apply a voltage to a load that is outside the range specified for that load.

Avoid Electric Shock.

To avoid injury or loss of life, do not connect or disconnect cables while they are connected to a voltage source.

Ground the Product.

This product is grounded through the grounding conductor of the power cord. To avoid electric shock, the grounding conductor must be connected to earth ground. Before making connections to any input or output terminals of the product, ensure that the product is properly grounded.

Do Not Operate Without Covers.

To avoid electric shock or fire hazard, do not operate this product with covers or panels removed.

Do Not Operate in Wet/Damp Conditions.

To avoid electric shock, do not operate this product in wet or damp conditions.

Do Not Operate in an Explosive Atmosphere.

To avoid injury or fire hazard, do not operate this product in an explosive atmosphere.

Do not install the crates on top of each other.

A minimum distance of 15 cm is required between the top of a crate and any other object over it.

3.1.2 Product Damage Precautions

Use Proper Power Source.

Do not operate this product from a power source that applies more than the voltage specified.

Provide Proper Ventilation.

To prevent product overheating, provide proper ventilation.

Do Not Operate With Suspected Failures.

If you suspect there is damage to this product, have it inspected by qualified service personnel.

3.1.3 **EC Certifications and Compliance**

Use in conformity of the definition with fully equipped mainframe with fully closed slots by boards or dummy panels. Sufficient cooling and mains connection must be secured according to regulations. Signal lines length during all tests was less than 3 m. The RS232 cable must be properly shielded and have a length of less than 3 m. Admitted for powering by industrial mains only.

3.1.4 **Terms in this Manual**

These terms may appear in this manual:

WARNING:

Warning statements identify conditions or practices that could result in injury or loss of life.

CAUTION:

Caution statements identify conditions or practices that could result in damage to this product or other property.

3.2 **Safety Terms and Symbols on the Product**

These terms may appear on the product:

- **DANGER** indicates an injury hazard immediately accessible as you read the marking.
- **WARNING** indicates an injury hazard not immediately accessible as you read the marking.
- **CAUTION** indicates a hazard to property including the product.

The following symbols may appear on the product:



DANGER
High Voltage



ATTENTION
Refer to Manual

3.3 **General Operation Requirements**

Before operation, check the following requirements:

Operating temperature:	5÷40°C (dry atmosphere)
Max. length of cables:	according to cable specifications



3.4 Power cords

The SY1527 system can be provided with either a 15 A tolerant power cord, or with a 10 A one. Each power cord has the following label:

 **WARNING!** 
**THIS CABLE SUPPORTS
A 15 A MAX CURRENT ONLY**

 **WARNING!** 
**THIS CABLE SUPPORTS
A 10 A MAX CURRENT ONLY**

The User must verify, before turning on, that the power cord and plug are suitable to SY1527 system configuration requirements, as reported on the following SY1527 back panel label:

 **WARNING!** 
**BEFORE TURNING ON VERIFY THAT
THE POWER SUPPLY CABLE AND THE
RELEVANT PLUG ARE SUITABLE TO
YOUR POWER REQUIREMENTS**

4. System and channel control

4.1 Introduction

All the parameters' readout or modification requests coming from different sources (local control devices, video terminal, H. S. CAENET controller, remote computers, etc.) are handled by the CPU of the system. The CPU also monitors the crate general parameters, such as H.S. CAENET Node address, RS232 Baud Rate, System Alarms and so on.

The current system status is stored in a permanent memory (EEPROM) so that all this information is not lost at Power-Off.

The Channel Boards as well house a microcontroller with its permanent memory (EEPROM) where it stores all the channels' parameters values. This feature allows easy upgrading and expansion of the system: new modules, or custom modules specially developed to fit the user's needs, can be added to the system without modifying the system CPU firmware.

The microcontroller has two main functions:

- control and monitoring of the channels of the board;
- communication with the system CPU.

The following sections contain an overview of the commands, parameters and alarms for the control and monitoring of the system and board channels.

4.2 System control

Several commands are available to control the system. These commands affect all the channels and can be sent to the system in different ways, depending on the type of command.

The most common way to forward a command to the system is to sent a proper input signal through the relevant connector on the front panel; however, for some commands a hardware input, like a button or a switch, has been foreseen.

The following sections are devoted to the description of the commands available.

Unless differently specified, all input signals mentioned below are referred to a common ground (COMMON GROUND) and are galvanically insulated up to 150 V with respect to the ground of the crate (CRATE GROUND).

For further details on electro-mechanical specifications of the components please refer to the *Technical Specifications* Section in the *Hardware Installation Guide*. A short summary of all front panel components is also given in Table 2.2 and Table 2.3, respectively.

For component location on the front panel please refer to the figure in Appendix A.

4.2.1 **NIM / TTL standard selection**

A two-position switch, located on the front panel, allows to select the standard for almost all the control output signals.

Nominally, the switch position affects the standard of the OVC, UNV, OVV, CH-ON, RST FLAG, CHK PASSED, TRIP and GEN signals.

The standard for the inputs on the front panel can be either NIM or TTL independently from the position of this switch.

The two switch positions correspond to:

- *Left position (NIM):* **NIM** standard (relevant green LED alight)
- *Right position (TTL):* **TTL** standard (relevant green LED alight).

4.2.2 **LOCAL/REMOTE Power-On**

The system can be powered on either locally or remotely. The **POWER-ON key**, located on the front panel of the Primary Power Supply, has three different positions:

- *Central position (OFF):* the system is turned off;
- *Right position (LOCAL):* the system is turned on locally;
- *Left position (REMOTE):* the system is enabled to be turned on remotely: the remote power on of the system will occur by sending a proper **REMOTE IN input signal** through the relevant connector.

The REMOTE IN input signal must be a +12 V input level (50 mA max.; tolerance: -40% ÷ +20%). As the REMOTE IN connector is supplied with +12 V, the REMOTE OUT connector provides itself a +12 V voltage level (with a delay of some seconds; tolerance: -20% ÷ +20%) that can be used to power on another crate remotely. This feature allows to power on many crates with a single signal.

The **OK** yellow LED lights up as the system is powered on, either locally or remotely.

N.B. The system can be turned on only if the MAIN switch on the rear panel is in the position 1.

4.2.3 **LOCAL/REMOTE Channel Enable**

The channel outputs can be enabled either locally or remotely.

A three-position lever switch (**LOC ENABLE / REM ENABLE / DISABLE switch**) allows for the selection of the enable mode:

- *Central position (DISABLE):* the channel outputs are disabled;
- *Upper position (LOC ENABLE):* the channel outputs are enabled locally (LOC ENABLE red LED on);
- *Lower position (REM ENABLE):* the channel outputs can be enabled remotely: the remote enable of the channel outputs will occur by sending a proper **ENABLE input signal** through the relevant connector (the REM ENABLE red LED is alight as the ENABLE signal is TRUE).

As the channels are enabled either locally or remotely, their output voltages of the channels which are ON increase up to the programmed value (V0SET or V1SET, according to the level of the VSEL input; refer to § 4.2.4, p.26) with the rate determined by the Ramp-Up parameter. The channels which are OFF will remain OFF.

If the channels are disabled via the switch (DISABLE position), the output voltages of the channels which are ON drop to 0 at the rate determined by the Ramp-Down parameters. If then they are enabled again, they restore the previous state bringing the output voltage to the programmed value at the rate determined by the Ramp-Up parameters.

4.2.4 **VSEL command**

Two Voltage values can be programmed for each channel: V0SET and V1SET (see § 4.4.5 and 4.4.7, p.32). They are selected by the status of the **VSEL input signal**, according to the following:

VSEL input signal	Selected Output voltage	VSEL green LED
VSEL False	V0SET	LED OFF
VSEL True	V1SET	LED ON

When channels are switched from V0SET to V1SET or vice versa, the output voltage drifts from one value to the other at the rate programmed for each channel (Ramp-Up or Ramp-Down parameter).

4.2.5 **ISEL command**

Two current limit values can be programmed for each channel: I0SET and I1SET (see § 4.4.6 and 4.4.8, p.32). They are selected by the status of the **ISEL input signal**, according to the following:

ISEL input signal	Selected Current limit	ISEL green LED
ISEL False	I0SET	LED OFF
ISEL True	I1SET	LED ON

4.2.6 **KILL command**

The **KILL input signal**, sent through the relevant connector, allows to switch all the channels off at the maximum rate available, regardless of the Ramp-Down or other parameters.

The relevant green LED will be alight as the KILL signal is True.

The KILL command can be also forwarded via software from the **Utility → Kill** menu. Please refer to § 7.1.15, p.58 for further details.

4.2.7 **RESET command**

The RESET command (available with system firmware rev. 20031120 and higher and software rev. 2.00.02 and later)¹ allows via the **RESET input signal** or the **RESET push-button** to reset the system CPU and, optionally, to reset the boards and to turn all the channels off. The action of the RESET command depends on the duration of the signal or of the press action (refer to Fig. 4.1):

¹ The running firmware and software can be monitored via the Tech Info menu (see § 7.1.6).

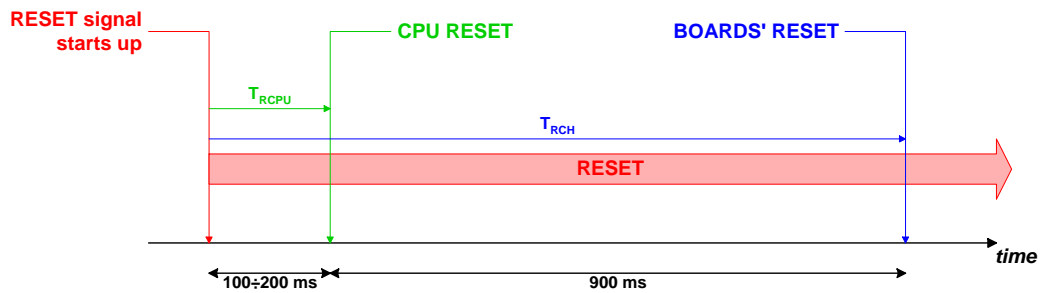

Fig. 4.1 – RESET timing

- If the RESET signal is longer than $T_{RCPU}=100\div 200$ ms (RESET LED red), only the CPU is reset and the whole system resumes its operation from the beginning. All the channels which are ON remain ON, all the channels which are OFF remain OFF.
- If the RESET signal is longer than $T_{RCH}= T_{RCPU} + 900$ ms (RESET LED orange), also the boards are reset and the channels which are ON are dropped to zero at the maximum rate available and turned off.

After the RESET, the system will react so as to at Power-On: if the Power-On option (refer to § 4.4.15, p.34) is enabled, each channel will be restored in the same condition it was before the RESET at the correct rate. If it is disabled, all the channels will be off, independently from the condition in which they were before the RESET.

N.B.: please note that any type of reset command must be enabled via software in the RESET FLAG window by tagging the relevant reset condition with an asterisk.

The occurrence of a RESET is also signalled by the RST FLAG output signal, according to the user's settings in the **Set-up → Reset Flag** menu (refer to § 4.3.5, p.29).

4.2.8 INTERLOCK command

The INTERLOCK command allows to switch off simultaneously all the channels, similarly to the KILL command (see § 4.2.6, p.26).

The INTERLOCK command can be activated via the **INTERLOCK input** which acts as an open/closed contact. The selection of the contact position (open or closed) which will cause the INTERLOCK command is performed via the two-position **INTERLOCK switch**:

- *Upper position (OPEN):* the channels are switched off as the INTERLOCK contact is open (the ground connection in the INTERLOCK input is removed);
- *Lower position (CLOSED):* the channels are switched off as the INTERLOCK contact is closed (the INTERLOCK input is grounded).

The INTERLOCK condition of the system is signalled by the INTERLOCK red LED alight.

In order to turn the channels on again, the user must remove the INTERLOCK condition. Any attempt to turn the channels on without removing the INTERLOCK condition will result unsuccessful.

4.2.9 HV SYNC

HVSYNC is the synchronisation clock for the Power Supply Units (RS485 standard, 1.25 MHz). It can work either as MASTER (MASTER red LED on), i.e. the synchronisation clock is internally generated and the HVSYNC connector works as output, or as SLAVE (MASTER red LED off), i.e. the synchronisation clock is externally generated and sent through the HV SYNC connector which works as input.

For the relative settings please refer to the **Set-Up → HV Clock Conf.** menu (§ 7.1.26, p.74).

4.3 System status monitoring

Several output signals and alarms are available to monitor the system status, as described in the following subsections.

Please note that all output signals mentioned below, unless differently specified, are referred to a common ground (COMMON GROUND) and are galvanically insulated up to 150 V with respect to the ground of the crate (CRATE GROUND).

For further details on electro-mechanical specifications of the components please refer to the *Technical Specifications* Section in the *Hardware Installation Guide*. A short summary of all front panel components is also given in Table 2.2 and Table 2.3 respectively.

For component location on the front panel please refer to the figure in Appendix A.

4.3.1 Over Current

The **Over Current** condition (**OVC**) occurs when at least one channel is in **Over Current** condition, i.e. at least one channel has reached the current limit. The Over Current condition is signalled by the OVC output signal True and the relevant red LED on. The system detects this condition as a fault and reacts according to the setting of the **TRIP** parameter (see § 4.4.13, p.33 for its definition), namely:

1) **TRIP = 1000 (constant CURRENT mode)**

If the Board has programmable current hardware protections, the output voltage is varied to keep the current below the programmed limit (I0SET or I1SET, according to the ISEL signal level). The channel behaves like a current generator.

If the Board has fixed current hardware protections, the output current is permitted to exceed the ISET value; the channel behaves like a current generator only if the maximum current value is reached.

2) **0 < TRIP < 1000 (TRIP mode)**

In this case, the channel behaves as in the constant CURRENT mode for a time equal to the finite value set as TRIP parameter, and then it is switched off according to the selected **Power-Down** option (KILL/RAMP). If the **Kill** option is selected, the channel will be switched off at the maximum rate available. If the **Ramp** option is selected, the voltage will drop to zero at a rate determined by the value of the **Ramp** parameter programmed for that channel.

4.3.2 **Under Voltage**

The **Under Voltage** condition (UNV) occurs when at least one channel is in **Under Voltage** condition, i.e. when:

- the actual value of the channel output voltage is lower than the programmed value.

The Under Voltage condition is signalled by the UNV output signal True and the relevant red LED on.

4.3.3 **Over Voltage**

The **Over Voltage** condition occurs when at least one channel is in **Over Voltage** condition, i.e. when:

- the actual value of the channel output voltage is higher than the programmed value.

The Over Voltage condition is signalled by the OVV output signal True and the relevant red LED on.

4.3.4 **Trip**

The **TRIP** condition occurs as at least one channel has tripped and has been switched off due to an Over Current condition (see § 4.3.1, p.28).

This condition is signalled by the TRIP output signal which is asserted True and the relevant red LED alight.

To recover from this state it is sufficient to turn the tripped channel On again or to execute a clear alarm command via software.

4.3.5 **Reset flag**

RST FLAG (RESET FLAG) output signal is TRUE (and relevant red LED on) after a RESET occurred, according to the user's settings. The type of reset which asserts RST FLAG TRUE can actually be selected via the **Set-up → Reset Flag** menu.

4.3.6 **Check passed**

CHK PASS (CHECK PASSED) output signal is True (and the relevant green LED on) when the initial check of the system is successful and the system is ready.

At normal operation, this signal is True and the relevant green LED is ON.

This output signal becomes false either as the Fan failure LED is alight or as the Power failure LED is alight. As the condition which caused the CHECK PASSED being FALSE is removed, the CHECK PASSED signal becomes true again.

4.3.7 GEN

GEN (GENERAL STATUS) output signal is True (and relevant red LED on) according to a logic combination of OVC, UNV, OVV and TRIP. The logic combination of these conditions is defined by the user via the **Status** command in the **Utility** menu.

Refer to § 7.1.17, for further details.

4.3.8 CH-ON

CH-ON (CHANNEL ON) output signal is True (and the relevant red LED on) as at least one channel is ON (i.e. the channels are enabled and the POWER parameter of that channel is set to ON; see § 4.4.14).

4.3.9 Over Temperature

Over Temperature condition occurs when there is at least one board at a temperature out of the range **TMIN** ÷ **TMAX**, where **TMIN** and **TMAX** are two parameters depending on the board type (e.g., in the Mod. A1734 **TMIN** = 5°C and **TMAX** = 65°C).

As the Over Temperature condition is reached, the relevant front panel LED lights up.

4.3.10 Fan Failure

Fan Failure condition occurs when at least one of the 6 fans of the system has stopped or is turning below 20% of normal speed.

As the Fan Failure condition is reached, the relevant front panel LED lights up.

4.3.11 Pwr Failure

Power Failure condition occurs when there is a fault in the voltage supplies at the +12 V, -12 V or +48 V level.

As the Power Failure condition is reached, the relevant front panel LED lights up.

4.4 Channel Parameters

Several parameters are associated with each channel, the number and type of these parameters depending on the Board type. They can be programmed and monitored in different ways:

- via local control devices (**Local Control**) i.e. the LCD screen, the Keypad and the Compact Switch;
- via remote control devices (**Remote Control**) by using the interfaces provided with the system, such as the PS/2 connector, the RS232 interface, the H. S. CAENET link, etc.;

The following subsections contains a short description of all parameters associated with a standard HV Power Supply Board (HV PWS Board, Mod. A1734). Although the number and type of parameters associated to each channel depend on the board's model, the following includes almost all parameters you can find when using a CAEN PWS Board.

4.4.1 CHANNEL NUMBER (CH #)

CH # is the physical name of the channel which corresponds to its complete address (refer to Fig. 4.2).

A channel in each crate is therefore identified by three items:

- the number of the cluster to which the crate where the board is inserted belongs;
- the number of the slot in which the board is plugged;
- the number of the channel on the board.

For example, the channel 3 of the board plugged in the slot 5 of the SY1527 crate belonging to the cluster 0 is identified with the name "0.05.003".

This parameter is read out by the software and is always shown in the channels window (refer to § 7.1.9, p.49). It cannot be modified by the user.

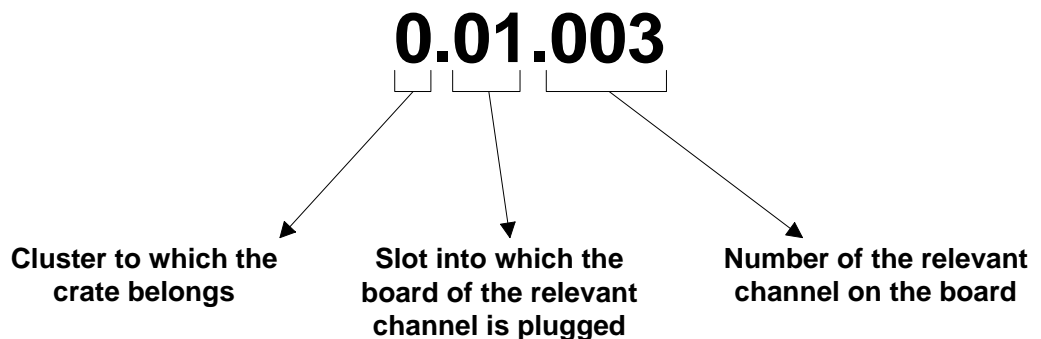

Fig. 4.2 – Complete Channel address

4.4.2 CHANNEL NAME (CHANNEL)

It is the symbolic name of the channel and, up to now, can be modified only via **Remote Control**. It may be up to 11 characters long and may contain any of the following characters:

"0..9", "A..Z", "a..z", "#", "&", "%", "\$", "*", "_", and "-".

NOTICE!

AN EXTERNAL KEYBOARD IS MANDATORY TO INPUT THE ALPHANUMERICAL DATA!

4.4.3 VMAX HARDWARE (HVMAX)

It is a hardware Voltage limit. Usually, it is fixed through a potentiometer placed on the board front panel and, consequently, cannot be modified via software.

4.4.4 VMAX SOFTWARE (SVMAX)

It is the maximum Voltage value programmable for the channel.
It can be programmed either via Local or Remote Control.

4.4.5 VOSET

It is the first of the two allowed Voltage programmable values (in absolute value).

It is active when the VSEL input signal is FALSE. It can be programmed either via Local or Remote Control.

4.4.6 IOSET

It is the first of the two allowed Current Limit programmable values (in absolute value).

It is active when the ISEL input signal is FALSE. It can be programmed either via Local or Remote Control.

4.4.7 V1SET

It is the second of the two allowed Voltage programmable values (in absolute value).
It is active when the VSEL input signal is TRUE. It can be programmed either via Local or Remote Control.

4.4.8 I1SET

It is the second of the two allowed Current Limit programmable values (in absolute value).

It is active when the ISEL input signal is TRUE. It can be programmed either via Local or Remote Control.

4.4.9 RAMP-UP (RUp)

Maximum Voltage programmable increase rate expressed in Volt/second. When a channel is switched On, or when it is switched from a lower Voltage value to a higher one, the Voltage output drifts from one value to the other at the rate expressed by the Ramp-Up parameter.

It can be programmed either via Local or Remote Control.

4.4.10 RAMP-DOWN (RDwn)

Maximum Voltage programmable decrease rate expressed in Volt/second (in absolute value). When a channel is switched Off, or when it is switched from a higher Voltage value to a lower one, the Voltage output drifts from one value to the other at the rate expressed by the Ramp-down parameter.

The output voltage of a channel drops to zero following the Ramp-down parameter when:

- the channel is switched Off (**POWER** Parameter = Off);
- the channel has tripped with $0 < \text{TRIP Parameter} < 1000$ (if the POWER-DOWN parameter is set to RAMP);
- the channels' outputs are disabled via the switch located on the front panel (LOC ENABLE/DISABLE/REM ENABLE switch).

It can be programmed either via Local or Remote Control.

4.4.11 VMON

Voltage Monitored value.

It can be monitored either via Local or Remote Control.

4.4.12 IMON

Current Monitored value.

It can be monitored either via Local or Remote Control.

4.4.13 TRIP

It is the maximum time an **Overcurrent** condition is allowed to last. If an **Overcurrent** condition lasts for more than the programmed value, the System will react in the following ways:

If **Trip = 1000**: **Constant Current mode.**

The over current condition may last indefinitely.

If the Board has programmable current hardware protections, the output voltage is varied to keep the current below the programmed limit (I0SET or I1SET, according to the ISEL signal level). The channel behaves like a current generator.

If the Board has fixed current hardware protections, the output current is permitted to exceed the ISET value; the channel behaves like a current generator only if the maximum current value is reached.

If $0 < \text{Trip} < 1000$: Trip mode.

The over current condition will cause the channel to "Trip": after an interval of time (equal to the Trip value) during which it behaves as in the constant CURRENT mode, the channel is switched off according to the selected POWER-DOWN option (KILL/RAMP). If the KILL option is selected, the channel will be switched off at the maximum rate available. If the RAMP option is selected, the voltage will drop to zero at a rate determined by the value of the RAMP parameter programmed for that channel.

The TRIP function is implemented by using a counter (TRIP counter) which is set to the programmed TRIP value each time one of the following actions is performed:

- the user sets the TRIP value;
- the user executes a clear alarm;
- the user powers on the channel (POWER parameter);
- otherwise, when the channel is no more in Over Current condition before the programmed TRIP value elapses.

This counter decreases as long as the channel is in Over Current condition and stops when one of the above conditions is met or the trip value is elapsed.

The TRIP parameter can be programmed either via Local or Remote Control.

4.4.14 POWER (PW)

It is the On/Off Status of the channel.

If the INTERLOCK is not active and the channels are enabled (see LOCAL/REMOTE Enable), the channel is turned On by setting this parameter ON.

As the channel is turned on, the output drifts from 0 to the programmed value (V0SET or V1SET according to the VSEL signal level) at the programmed rate (RAMP-UP parameter).

It can be programmed either via Local or Remote Control.

Setting the POWER parameter to ON automatically resets the alarm conditions. Moreover, it sets the TRIP counter again to its initial programmed value, so that the TRIP counter will start again from the programmed TRIP value as soon as another Over Current condition occurs. Refer to § 4.4.13, p.33 for further details on the TRIP counter.

4.4.15 POWER-ON (POn)

This parameter controls the behaviour of the channel at Power-On or after a Restart. It can be set as:

- Enabled (EN),
- Disabled (DIS).

If it is enabled, at Power-On or after a Restart each channel is restored in the same condition (defined by the POWER parameter) it was before the Power-Off or Reset. If this option is disabled, at Power-On or after a Restart all the channels are Off, independently from the condition in which they were before the Power-Off or Reset. It can be programmed either via Local or Remote Control.

4.4.16 **POWER-DOWN (PDwn)**

This parameter affects the way the channels react at a Power-Off command caused by a TRIP condition.

It can be set as:

- KILL,
- RAMP.

If the KILL option is selected, the relevant channel will be switched off immediately.

If the RAMP option is selected, the voltage will drop to zero at a rate determined by the value of the Ramp-Down parameter programmed for that channel.

It can be programmed either via Local or Remote Control.

4.5 **Channel status**

Several messages on the status of each channel are displayed by the User Software Interface and particularly in the **Channels Window**. For a list of these messages please refer to § 7.1.9, p.49.

4.6 **Board status**

Several messages on the board status are displayed by the User Software Interface. In particular, in the **Channels Window** there is a column displaying the temperature detected on the PCB of the board (**TEMP** column) and another one displaying various messages on the board status. For a list of these messages please refer to § 7.1.9, p.49.

5. System Power-On

The Power-ON of the system can be performed either locally or remotely, as described in the following subsections.

5.1 Preliminary check

Before powering the system, check that:

1. The Primary Power Supply and the Power Supply Units are inserted correctly in their relevant housings and fixed with the relevant screws (for details refer to § 7.1.1 in the *Hardware Installation Guide*);
2. The boards, after the required hardware settings (see the *User's Manual* of the board), are plugged into the slots and fixed properly (for details refer to § 7.1.2 in the *Hardware Installation Guide*);
3. The crate is connected to the mains correctly (for details refer to § 7.1.3 in the *Hardware Installation Guide*);
4. Cabling has been performed according to the instructions given in § 7.4 in the *Hardware Installation Guide*, with reference to the chosen hardware set-up;
5. Safety instructions, installation requirements and operation requirements given in Section 6 of *Hardware Installation Guide* and in § 3.3, p.22 of this manual, respectively, have been thoroughly complied.

5.2 Local Power-On

To power-On the system locally follow this procedure:

1. Turn on the MAIN switch located on the rear panel of the crate: the MAIN LED (orange), located on the front panel of the Primary Power Supply (refer to Front Panel figure in the Appendix), lights up.
2. Turn the Power-On key, located on the front panel of the Primary Power Supply (refer to Front Panel figure in the Appendix), in the right position (ON LOCAL): the OK LED (yellow), located on the front panel of the Primary Power Supply, lights up and the fan tray unit starts to work.

Following these operations, the following LEDs will be alight on the front panels of the Primary Power Supply (PPS) and of the Power Supply Units (PSUs) (refer to Front Panel figure in the Appendix):

- +5** (green LED on PPS): it indicates the presence of +5 V power supply; if it is off it indicates that there is a fault.
- +12** (green LED on PPS): it indicates the presence of +12 V power supply; if it is off it indicates that there is a fault.
- 12** (green LED on PPS): it indicates the presence of -12 V power supply; if it is off it indicates that there is a fault.
- +48** (green LED on PSU): it indicates the presence of +48 V power supply; if it is off it indicates that there is a fault.

After the initial check of the system, the **Welcome Screen** of the User Software Interface will appear on the LCD screen (refer to Fig. 7.3, p.45).

5.3 Remote Power-On

To power-On the system remotely follow this procedure:

1. Turn on the MAIN switch located on the rear panel of the crate: the MAIN LED (orange), located on the front panel of the Primary Power Supply (refer to Front Panel figure in the Appendix), lights up.
2. Turn the Power-On key, located on the front panel of the Primary Power Supply (refer to Front Panel figure in the Appendix), in the left position (ON REMOTE);
3. Send a proper signal (refer to § 4.2.2, p.25 for details) through the REMOTE IN input connector on the front panel of the Primary Power Supply: the OK LED (yellow), located on the front panel of the Primary Power Supply, will light up and the fan tray unit starts to work.

Following these operations, the LEDs listed below will be alight on the front panels of the Primary Power Supply (PPS) and of the Power Supply Units (PSUs) (refer to Front Panel figure in the Appendix):

- +5** (green LED on PPS): it indicates the presence of +5 V power supply; if it is off it indicates that there is a fault.
- +12** (green LED on PPS): it indicates the presence of +12 V power supply; if it is off it indicates that there is a fault.
- 12** (green LED on PPS): it indicates the presence of -12 V power supply; if it is off it indicates that there is a fault.
- +48** (green LED on PSU): it indicates the presence of +48 V power supply; if it is off it indicates that there is a fault.

After the initial check of the system, the **Welcome Screen** of the User Software Interface will appear on the LCD screen (refer to Fig. 7.3, p.45).

5.3.1 MAIN switch

The MAIN switch located on the rear panel of the crate is provided by a ABB S202-C40 Miniature circuit breaker

Rated breaking capacity according to IEC 947-2:

230V input: ultimate I_{cu} [kA] 20; service I_{cs} [kA] 15

400V input: ultimate I_{cu} [kA] 10; service I_{cs} [kA] 7.5

See http://www.abb-control.com/pdf/catalog/lv023/14.1-34_S200.pdf

for more electrical features.

6. Configuring the interfaces

6.1 RS232 interface

The RS232 interface provided with the system is a 9-pin D-type male RS232 serial port and can be used to interface a VT100 terminal or an external standard IBM™ Personal Computer running a terminal emulator program (*Remote operation via terminal using the RS232 interface*, see § 7.2.1). This interface can be also used to connect the system to an external standard IBM™ Personal Computer running a custom-developed program (*Remote operation via host computer*, see § 7.3).

The default settings of the RS232 interface are as listed in Table 6.1, while the RS232 pin assignment is given in Fig. 6.1.

The menu to modify the RS232 interface settings can be accessed from the **Set-Up Menu → Communications → RS232 settings**. Refer to § 7.1.23 for further details.

Table 6.1 – RS232 Port Default Settings

Baud rate	57600
Parity	None
Character length	8 bits
Number of stop bits	1 bit
Flow control	Xon/Xoff

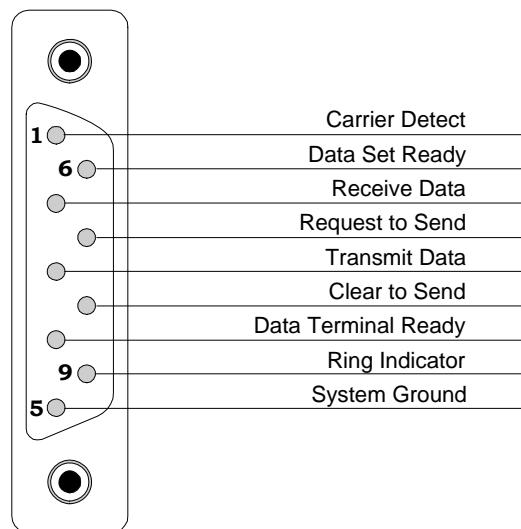

9-pin D-type male RS232 connector

Fig. 6.1 – RS232 connector pin assignment

6.2 Ethernet interface (TCP/IP protocol)

The Ethernet connector provided with the system is a 10/100baseT connector and can be used to interface the SY1527 system to an Ethernet LAN. This allows the system control via an external standard IBM™ Personal Computer running a Telnet Client terminal emulator program (*Remote operation via terminal using the TCP/IP protocol*, see § 7.2.3) or to a computer connected to a TCP/IP network (INTERNET/INTRANET) and running a custom-developed program (*Remote operation via host computer*, see § 7.3).

6.2.1 Configuring the SY 1527 System for network connection

Before establishing a connection to a TCP/IP network, a specific IP Address, IP Net Mask must be assigned by the local Network Administrator to the SY 1527 System. The default settings of the TCP/IP protocol for the SY 1527 System are as listed in Table 6.2: the default settings correspond to the network connection inactive.

Table 6.2 – TCP/IP Protocol Default Settings

IP Address	0.0.0.0
IP Net Mask	0.0.0.0
Gateway	0.0.0.0

Default TCP/IP settings can be modified by the User in the Start Up Window selecting:

Set-Up Menu → Communications → TCP/IP settings

Refer to § 7.1.23 for further details. An example of possible TCP/IP settings is listed in the table below.

Table 6.3 – An example of TCP/IP Protocol Settings

IP Address	192.9.200.1
IP Net Mask	255.255.255.0
Gateway	0.0.0.0

If the User needs to connect to the SY 1527 system from outside the local network, a Gateway address has to be specified in the TCP/IP settings.

6.2.2 Configuring the host PC

To configure the TCP/IP parameters of the host PC with Windows 9x select:

Start → Settings → Control Panel

Double-click on the Network icon in the Control Panel. Double-click on the **TCP/IP** line in the network dialog box then select **Specify an IP address**.

If this has already been selected, the computer's IP address is set and nothing more needs to be done. Cancel out of the TCP/IP and network dialog boxes and close the control panel. However if the address has not already been selected, fill in the computer's IP address and Net Mask.

6.2.3 Verifying connection

The network connection between the SY 1527 system and the host PC can be verified using the "ping" command, available on Windows 9x/NT with TCP/IP protocol installed. In order to check the network connection start MS-DOS prompt and type:

ping < SY 1527 IP address >

where < SY 1527 IP address > is the IP address assigned to the SY 1527 system. The dialog box below illustrates the result of a successful "ping" with the Ethernet connection shown established.

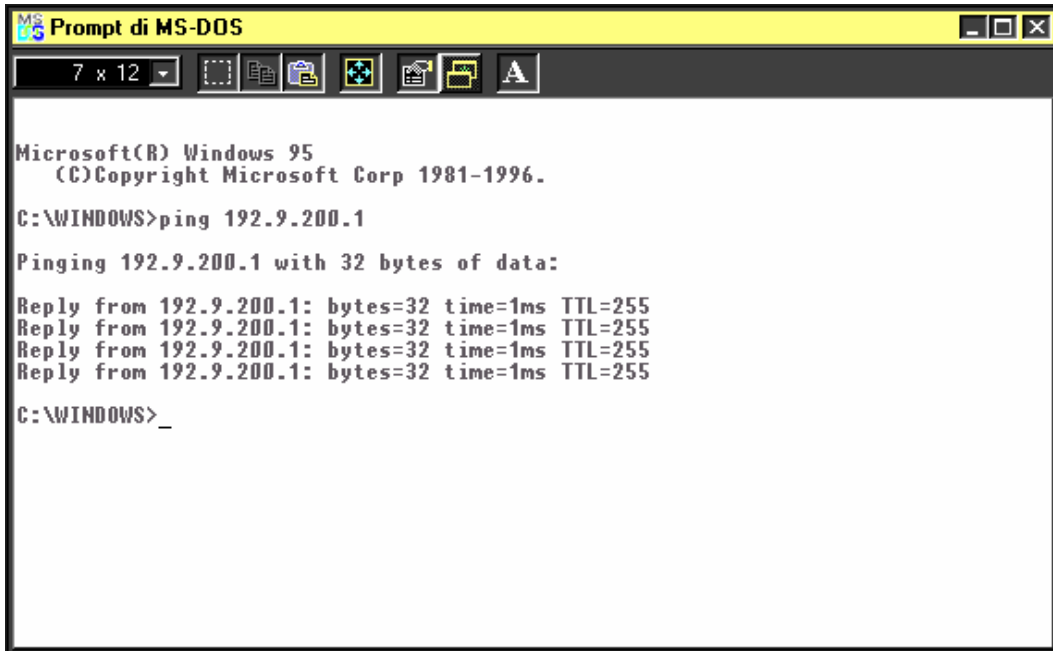

Fig. 6.2 - The result of a successful "ping" to the SY 1527 system

The ping command has sent a message to the SY 1527 system and waited for a response. If the request is timed out the network connection is not working properly.

6.3 H.S. CAENET interface

The H.S. CAENET interface provided with the system allows control via another SY1527 crate connected to an external standard Personal Computer via RS232 interface and running a terminal emulator program (*Remote operation via terminal using the H.S. CAENET*, i.e. *Multicrate Operation*, see § 7.2.2).

The only H.S. CAENET interface setting concerns the crate number, i.e. the number assigned to the crate for its identification inside the H:S: CAENET daisy-chain (see § 7.1.23). Default setting is reported in Table 6.4.

The menu to modify the H.S. CAENET settings can be accessed from

Set-Up Menu → Communications → H.S. CAENET settings.

Table 6.4 – H.S. CAENET Default Settings

Crate Number	01
---------------------	----

7. Operating modes

The operating modes supported by the System are:

- Standalone operation
- Remote operation via terminal by using either the RS232 or Telnet connection
- Remote operation via terminal by using the H.S. CAENET (*Multicrate operation*)
- Remote operation via host computer by using TCP/IP protocol (OPC Server and CAEN HV Wrapper Library).

7.1 Standalone operation

Standalone Operation is intended as the interactive control and monitoring of one SY1527 system by using the only control devices located on the front panel (LCD, keypad and compact switch) or, optionally, an external keyboard and/or VGA monitor which can be connected to the system to make an easier input and monitoring of the data (refer to Fig. 7.1).

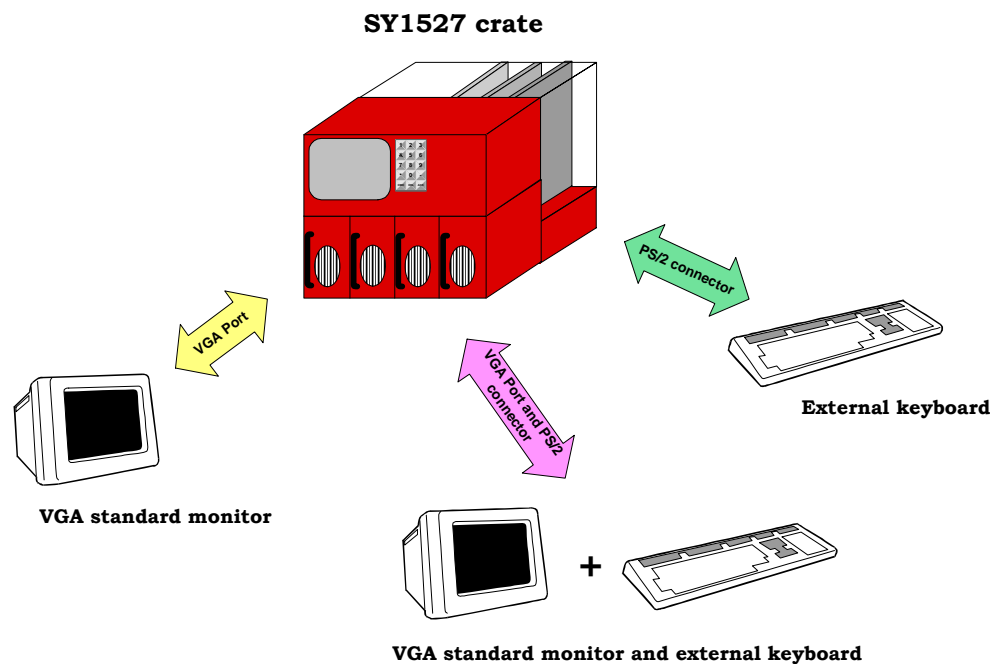

Fig. 7.1 – Standalone Operation

The keyboard can be plugged into one PS/2 connector located on the front panel, while the standard VGA monitor can be connected to the VGA port placed on the front panel. For further details on the electro-mechanical specifications refer to § 4.3.3 of the Technical Specifications Section in the *Hardware Installation Guide*.

NOTICE

AN EXTERNAL KEYBOARD IS MANDATORY TO INPUT THE ALPHANUMERICAL DATA!

7.1.1 Local Control Devices

7.1.1.1 LCD screen

The crate is provided with a VGA-standard 7.7" colour LCD screen (640x480 resolution). Four buttons (+/- **CONTRAST** and +/- **BRIGHT**), placed just below the screen, allow to adjust the brightness and contrast of the monitor.

7.1.1.2 Keypad

The keypad has 15 keys consisting of 10 numerical keys from "0" to "9", the keys "+" and "-", and the keys "CMD", "DEL" and "ACK".

The latter are the COMMAND, DELETE and ACKNOWLEDGE commands, respectively.

- The **COMMAND** key allows to select the *Menu Bar* at the top of the screen (see the description of the Start Up Menu).
- The **DELETE** key is the usual DELETE command.
- The **ACKNOWLEDGE** key corresponds to the usual ENTER command.

The relation between commands from Local Control Devices and commands from a standard keyboard are summarised in Table 7.1.

7.1.1.3 Compact Switch

The compact switch, placed underneath the keypad on the front panel, can assume 8 positions plus the press action. The latter corresponds to the command SPACEBAR from the keyboard.

The compact switch allows to:

- move on the screen, by moving the lever toward one of its 8 directions;
- switch among the options available for the currently selected field by pressing the lever.

Table 7.1 – Local control commands and external keyboard commands

Local control commands	Keyboard commands
CMD keypad key	TAB key
DEL keypad key	DELETE key
ACK keypad key	ENTER key
Compact Switch (press action)	SPACE Bar
Compact Switch (4 directions)	Arrow keys

NOTICE

THERE ARE ONLY 4 DIRECTIONS ENABLED (Up, Down, Right, Left) TO MOVE ON THE SCREEN WITH THE COMPACT SWITCH!
Mod. SY1527LC does NOT feature the compact switch, therefore it is necessary to use the Keyboard commands listed in table 7.1

7.1.2 **Software Version**

Description of the *User Interface Software* running on the SY1527 system refers to the:

Software Version x.yy.zz

A variation in the last two figures (.zz) of the software version refers to a debug operation; a variation in the two figures placed in the middle (.yy.) refers to a feature upgrading of the software version; a variation in the first figure (x.) refers to a radical change of the software version.

7.1.3 **Menu Structure**

At Power On in standalone configuration the *User Interface Software* will show a **Welcome Screen**.

By pressing any key the **Login Window** will be shown and, after the Login procedures, the **Start Up Window** will appear. The **Start Up Window** has a *Menu Bar* at the top of the screen through which the user can access all the commands.

The Menu structure is summarised in Fig. 7.2: the commands which appear in the *Menu Bar* of the **Start Up Window** are displayed as rounded squares with underneath the list of commands and windows which can be accessed. This *Menu Bar* is always present in all the windows: only in the **Channels** Window there are two further commands available in the Bar (**Groups** and **View** commands).

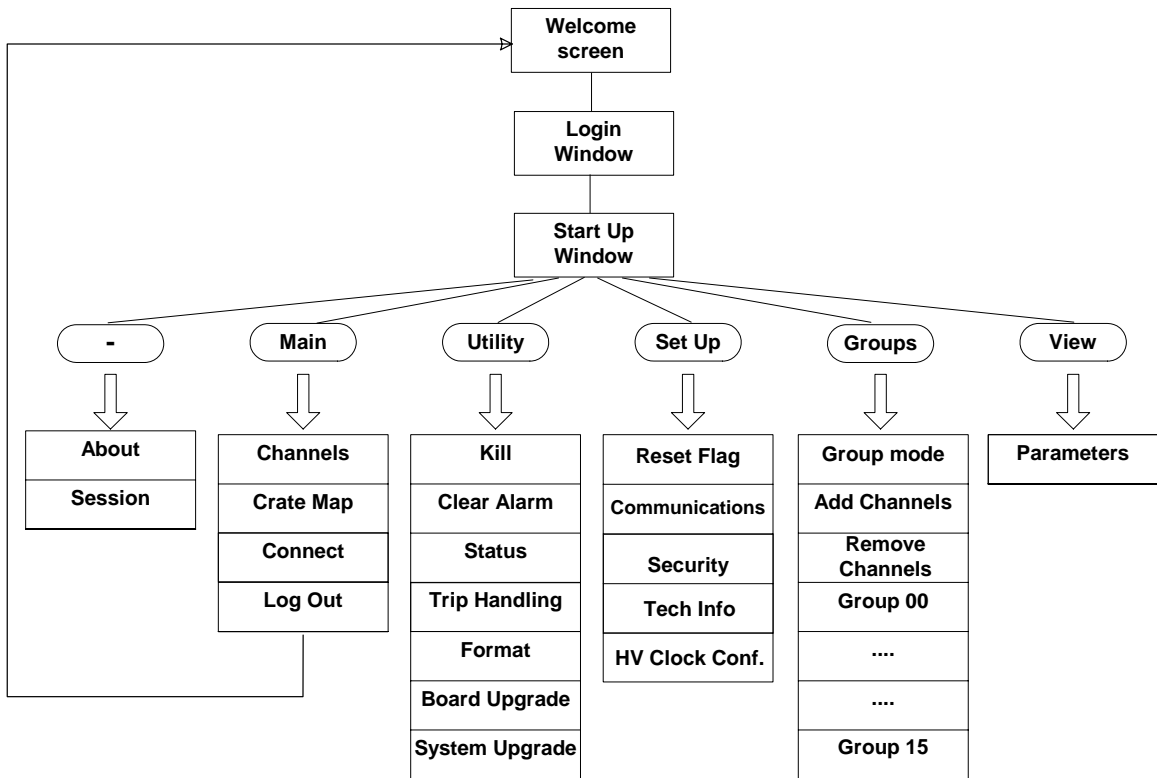

Fig. 7.2 – Menu Structure in standalone operation

7.1.4 **Welcome Window**

The **Welcome Window** which appears as the system is powered On is shown in Fig. 7.3.



Fig. 7.3 – Welcome Screen in Standalone Operation

7.1.5 **Login Window**

The **Login Window** is shown in Fig. 7.4.

In order to access the following **Start Up Window**, type the **Username** and the relevant **Password** in the relevant fields and then press ENTER (ACK key on the keypad).

Refer to § 9.1 for the list of the built-in profiles and information about the relevant access level.



Fig. 7.4 – Login Window

7.1.6 Start Up Window

The **Start Up Window** is shown in Fig. 7.5. The *Menu Bar* at the top of the window allows to enter all the other windows available, according to the structure shown in Fig. 7.2, p.44. On the top right it is also reported the access level type (for example: **User**).

The **-** menu gives access to:

- **About**, which displays the Welcome Screen;
- **Session**, which visualises the Session Window.

The **Main** menu gives access to:

- **Channels**, which displays the Channels Window;
- **Crate Map**, which displays the Crate Map Window;
- **Connect**, which is used for Multicrate Operation;
- **Logout**, which goes back to the Welcome Screen.

The **Utility** menu gives access to:

- **Kill**, which allows to kill all channels;
- **Clear Alarm**, which allows to remove all alarm conditions;
- **Status**, which allows to define the conditions to assert the GEN output signal;
- **Trip Handling**, which allows a sophisticated handling of trip conditions;
- **Format**, which allows the format operation of the system flash memory;
- **Board Upgrade** (visible only if you are logged as *Administrator*), which allows upgrading the board firmware;

- **System Upgrade** (visible only if you are logged as *Administrator*), which allows upgrading the system firmware.

The **Setup** menu gives access to:

- **Reset Flag**, which allows to enable the different reset conditions and to assert TRUE the RESET FLAG signal accordingly;
- **Communications**, which is used for interface settings;
- **Security**, which allows the Administrator to configure multilevel user's profiles
- **Tech Info**, which contains information about system operation;
- **HV Clock Conf.**, used for the configuration of the crate as MASTER or SLAVE for HV Clock synchronization and for connection to a SY3527 through the Local Net (see § 2.3).



Fig. 7.5 – Start Up Window

The following subsections contains a detailed description of each menu together with relevant commands and windows.

7.1.7 The - Menu: About

The **About** command, entered from the – menu that is the first on the left in the *Menu Bar*, displays the **About Window** (Fig. 7.6). It contains helpful information, nominally:

- **System Name**: this is a descriptive name of the system. This name cannot be used for the identification of the crate in Multicrate Operation.
- **Software Version**: this is the software version presently running on the system (Software Version x.yy.zz). A variation in the last two figures (.zz) of the software

version refers to a debug operation; a variation in the two figures placed in the middle (.yy.) refers to a feature upgrading of the software version; a variation in the first figure (x.) refers to a radical change of the software version.

To return to the *Menu bar*, press any key.

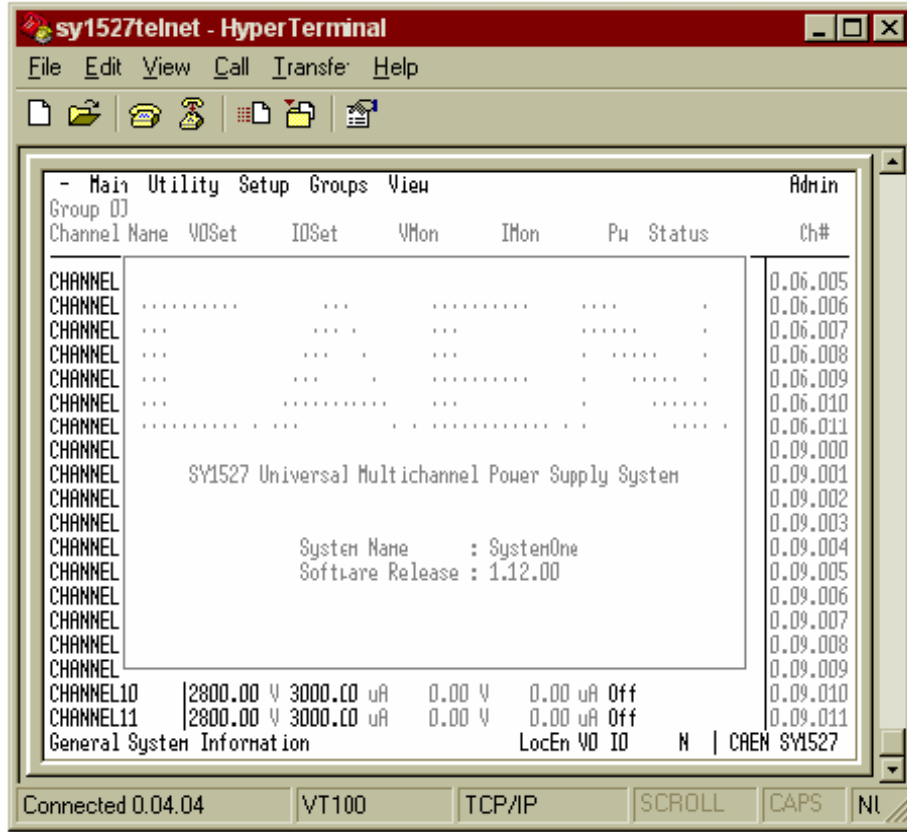

Fig. 7.6 – About Window

7.1.8 The - Menu: Session

The **Session Window**, entered from the – menu which is the first menu on the left in the *Menu Bar*, is shown in Fig.7.7: it displays all the users (**Username**) presently connected to the system and gives information about their Access Level as Guest, User or Administrator (**Level**), the Communication Line (**Comm Line**) they are using, the **Login Time**, i.e. the time (day, month, hour, year) at which they started the connection and the **IP Address** used.

For example, Fig.7.7 shows that there is only one user connected to the system. His **Username** is 'user', he is logged with a 'user' access **Level** and he is operating in standalone configuration ('Local' as **Communication Line** indicates that the user is currently connected to the system via no other interface but those compatible with the standalone operation: crate on-board control devices, external keyboard and external VGA monitor). The other communication line which can be displayed are: *Telnet*, *RS232*, *CAENET* and *CMD TCP/IP*. The latter one refers to a remote operation via host computer, i.e. either via OPC Server or CAEN HV Wrapper Library.

To return to the *Menu Bar*, press any key.

Current Sessions				
User Name	Level	Comm Line	Login Time	IP Address
1 admin	Admin	Cmd TCPIP	Tue Mar 18 12:11:14 2008	10.0.7.2
2 admin	Admin	Telnet	Tue Mar 18 12:14:28 2008	10.0.7.121_

View Active Sessions LocEn V0 I0 T ↓ CAEN SY1527

Fig. 7.7 – Session Window

7.1.9 The MAIN Menu: Channels

The **Channels** command is selectable from the Main menu, i.e. the second command from left in the *Menu Bar*. It enters the **Channels Window** which allows for the control and monitoring of the channel parameters and for the review of the board status.

The **Channels Window** is shown in Fig. 7.8 (in fact, this is only a partial view of the window since there are further parameter columns, listed on the right, which can be displayed by moving the cursor towards right either with the keyboard arrow keys or the compact switch).

The **Channel Window** can be divided into three sections:

- the *Menu Bar* at the top of the window with the current access level on the top right (e.g. *user*);
- the *Channel Parameters Columns* in the central area;
- the *Status Bar* at the bottom of the window.

Menu Bar

The *Menu Bar* of the **Channels Window** is different from that of the Start Up Menu since there are two further menus: **Groups** and **View**. For details on the commands they give access please refer to § 7.1.13 and § 7.1.14, p.55 and p.58, respectively.

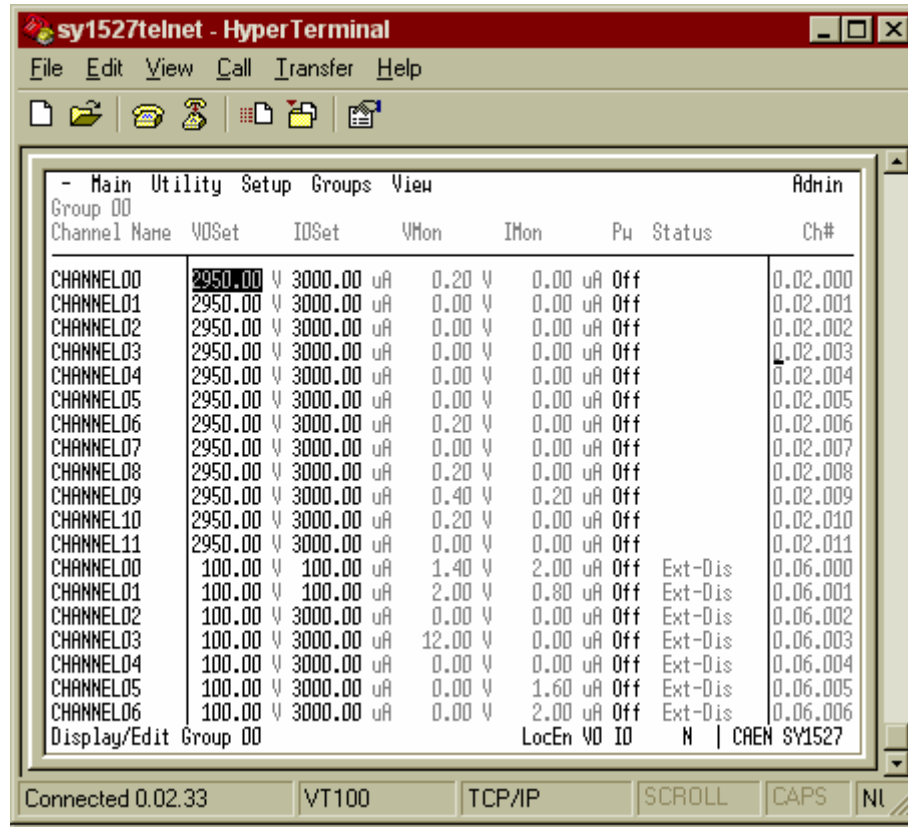

Fig. 7.8 – Channels Window

Channel Parameters Columns

Several parameters and alarm messages are listed in the *Channel Parameters Columns* placed underneath the *Menu Bar*. (for details on how to customise the type and position of the parameters to be displayed please refer to § 7.1.14, p.58) These parameters allow for channel parameter setting and for status control of the channels and of the boards inserted into the crate.

The parameters which can be set are displayed in a slight grey colour, the parameters which cannot be set but are just monitor parameters of the channel status or of the board status are white-coloured.

NOTICE!

**THE TYPES OF PARAMETERS AND ALARM MESSAGES
 DISPLAYED IN THE CHANNELS WINDOW DEPENDS ON THE TYPE OF BOARD
 USED: THE PARAMETERS AND ALARMS HERE BELOW REFER TO THE
 MOD. A1734 HV PWS BOARD!**

The parameters displayed in the **Channels Window** for each channel of each board are (from left to right):

- **CHANNEL NAME** (settable): descriptive name for the relevant channel².

² EASY3000 and EASY4000 Channel Names can be up to 6 characters long!

- **V0SET** (settable): the first of the two allowed voltage programmable values.
- **I0SET** (settable): the first of the two allowed current limit programmable values.
- **VMON** (monitor): monitored voltage value.
- **IMON** (monitor): monitored current value.
- **PW** (settable ON/OFF): the Power parameter shows the ON/OFF channel status. As this parameter is set ON, the channel is switched on (if the INTERLOCK is not active and if the channel is enabled either locally or remotely). *Press Compact Key / Space Bar to toggle*
- **STATUS** (monitor): it displays the channel status. Refer to § 7.1.9.1, p.52 for a list of the possible status which can be displayed here. The field becomes red if the channel is not in the steady status (normal operation). If the system is operated from an external terminal it blinks instead of being red.
- **TRIP** (settable): the TRIP parameter value, i.e. the maximum time an Over Current condition is allowed to last. Refer to § 4.4.13, p.33 for further details on the TRIP parameter.
- **SVMAX** (settable): the maximum voltage value programmable for the channel. If the value set as SVMAX is less than the current value of the V0SET/ V1SET parameter, the latter will automatically decrease to the SVMAX value.
- **V1SET** (settable): the second of the two allowed voltage programmable values.
- **I1SET** (settable): the second of the two allowed current limit programmable values.
- **RDWn** (settable): the Ramp-Down parameter value, i.e. the maximum voltage programmable decrease rate.
- **BdStatus** (monitor): it displays the status of the board. Refer to § 7.1.9.2, p.53 for a list of the possible board status which can be displayed here.
- **HVMAX** (monitor): the hardware voltage limit for the board channels. It is adjusted via the relevant trimmer placed on the board front panel.
- **TEMP** (monitor): the temperature value detected on the board by the relevant sensor. If this value is out of the range $TMIN \div TMAX$, where TMIN and TMAX are the two threshold temperature parameters depending on the type of board, the system signals an Over Temperature condition (see § 4.3.9). Refer to the *User's Manual* of the relevant board for further details.
- **RUp** (settable): the Ramp-Up parameter value, i.e. the maximum voltage programmable increase rate.
- **POn** (settable EN/DIS): Power-On option, which can be enabled or disabled. If this option is enabled, at Power-On or after a Restart each channel is restored in the same condition (defined by the Power parameter) it was before the Power-Off or Reset. If this option is disabled, at Power-On or after a Restart all the channels are off, independently from the condition in which they were before the Power-Off or Reset. *Press Compact Key / Space Bar to toggle*
- **PDwn** (settable KILL/RAMP): Power-Down option, which can be set as KILL or RAMP. It affects the way the channels react at a Power-Off command caused by a TRIP condition. If the KILL option is

selected, the relevant channel will be switched off at the maximum rate available. If the RAMP option is selected, the voltage will drop to zero at a rate determined by the value of the Ramp-Down parameter programmed for that channel.

Press Compact Key / Space Bar to toggle

- **CH # (monitor):** Channel address. It consists of three numbers (refer to Fig. 4.2): the first indicates the cluster to which the crate belongs, the second number indicates the slot where the relevant channel board is plugged into, and the third number identifies the number of the channel. Refer to § 2.1, p.11 for the definition of cluster.
This field becomes red if the channel is not in a steady status (normal operation). If the system is operated from an external terminal it blinks instead of being red.

Both the compact switch or the arrow keys of a standard keyboard can be used to move through the columns containing the parameters.

To return to the *Menu Bar*, press the TAB key (COMMAND key on the keypad).

The channel parameters visualisation described above refer to the **Group 00**, which, by default, is the channel group containing all the channels available. It is also possible to display just a subset of the channels available by defining a different channel group. This operation is performed through the **Groups** menu in the *Menu Bar* displayed as the **Channels Window** is entered. This menu is fully explained in § 7.1.13, p.55. Moreover, it is possible to customise the number, type and position of the parameters to be displayed. This is done via the **View** menu, as described in § 7.1.14, p.58.

Status Bar

The *Status Bar*, located at the bottom of the window, provides some useful information, nominally (from left to right):

- **Operation type:** it displays the type of operation which is running or which is presently selected in the *Menu Bar*.
- **Loc En / Rem En:** it displays if the channels are enabled locally (**Loc En**) or remotely (**Rem En**). If the channels are disabled, no information is displayed.
- **V0 I0 / V1 I1:** it displays if the channels are in the V0 I0 status (**V0 I0**) or in the V1 I1 status (**V1 I1**).
- **I:** the system is in INTERLOCK.
- **K:** the system is in KILL.
- **T / N:** it indicates if either the TTL (**T**) or the NIM (**N**) standard were selected via the relevant switch.
- **◆:** this red diamond is displayed if at least one channel is ON (i.e. at least one channel has the PW parameter set ON).
- **CAEN SY1527:** it blinks to indicate error of communication with a board plugged into the crate. If the communication error source is removed, the error status is reset (i.e. the CAEN SY1527 does not blink any more) by entering and then exiting the **Crate Map** window.

7.1.9.1 Channel Status

The channel status messages which can be displayed in the **Status** parameter column of the **Channels Window** are as follows:

- **Cal Err:** Calibration Error: at least one of the calibrations for at least one of the channels is not correct.
- **Up:** the channel is ramping up.
- **E Trip-Dwn:** an external TRIP occurred: the channel is ramping down.
- **I Trip-Dwn:** an internal TRIP occurred: the channel is ramping down.
- **OvC Dwn:** an Over Current condition occurred: the channel is ramping down due to the intervention of the user (not for a TRIP condition).
- **E Dis Dwn:** an external DISABLE occurred: the channel is ramping down.
- **Dwn:** the channel is ramping down (only in the case that none of the **E Trip-Dwn**, **I Trip-Dwn**, **OvC Dwn** and **E Dis Dwn** conditions occurred).
- **E Tripped:** the channel is off due to an external TRIP.
- **I Tripped:** the channel is off due to an internal TRIP.
- **Ext-Dis:** the channel is off due to the fact that the board was disabled via the HV EN input connector on its front panel.
- **OvC:** the channel is in Over Current condition, i.e. the channel has reached the current limit.
- **UnV:** the channel is in Under Voltage condition, i.e. the actual value of the channel output voltage is lower than the programmed value.
- **OvV:** the channel is in Over Voltage condition, i.e. the actual value of the channel output voltage is higher than the programmed value.
- **HVmax:** the channel output voltage has reached the HVMAX hardware voltage output limit.

This field becomes red if the channel is not in a steady status (normal operation). If the system is operated from an external terminal it blinks instead of being red.

7.1.9.2 Board Status

The possible board status which can be displayed in the **Bd Status** column of the **Channels Window** are as follows:

- **Pw Fault:** power supply fault on the board.
- **Fw Err:** firmware error on the board.
- **VMAX Cal Err:** calibration error for the HVMAX parameter of the board.
- **T Cal Err:** calibration error for the temperature detection on the board.

This field becomes red if the board is not in a steady status (normal operation). If the system is operated from an external terminal it blinks instead of being red.

7.1.10 The MAIN Menu: Crate Map

Crate Map is entered from the Main menu and opens the **Crate Map Window** showing what types of boards are inserted into the crate and in which slot they are plugged into. The **Crate Map Window** is shown in Fig. 7.9: the first column on the left indicates the number of the Slot (from 0 to 15) together with the model of the board inserted into the slot (if any). A short description of the board with its features and serial number follows the board model.

Moreover, if there is an error of communication with a board inserted into a slot of the crate, the relevant board blinks. As soon as the error source is removed, the board stops blinking. Entering the **Crate Map Window** allows as well for the reset of communication error status, i.e. if the communication error source is removed and the **Crate Map Window** is entered, the CAEN SY1527 label in the status bar stops blinking on exiting the **Crate Map Window**. Conversely, if the communication error source has not been removed, the CAEN SY1527 label will go on blinking.

To return to the *Menu Bar*, press any key.

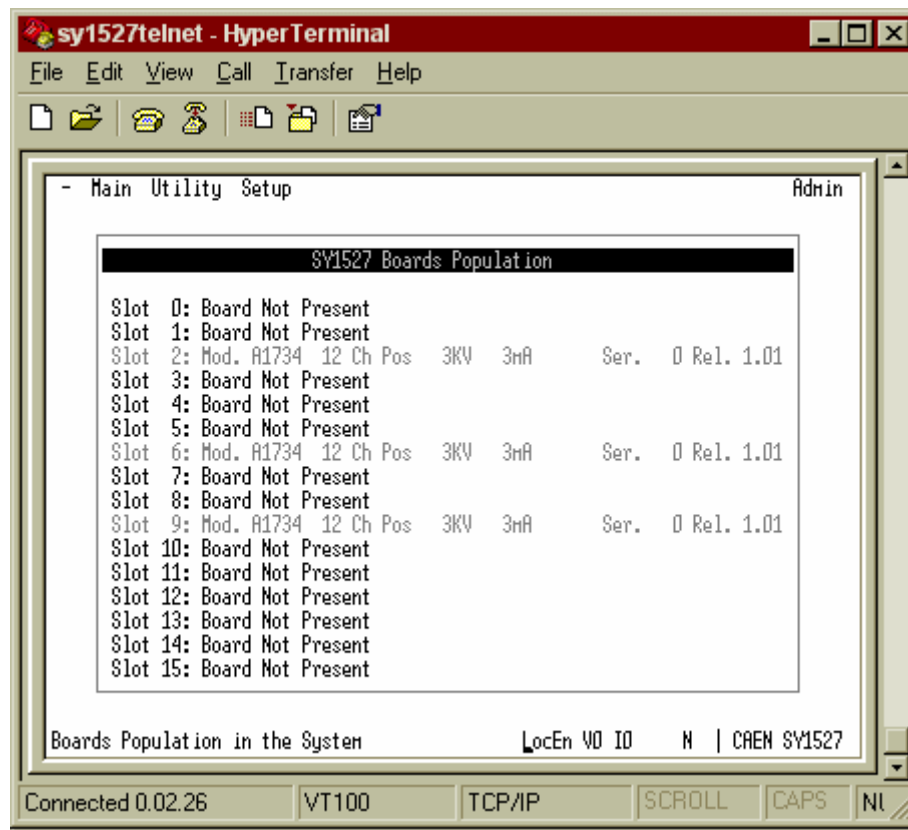

Fig. 7.9 – Crate Map Window

7.1.11 The MAIN Menu: Connect

The **Connect** command allows to operate in Multicrate mode: it is possible to control via H.S. CAENET a remote slave Power Supply System. To establish the connection, it's necessary to insert the remote system CAENET crate number (1 to 99) and then select Ok. Select Cancel to exit from the dialog window.

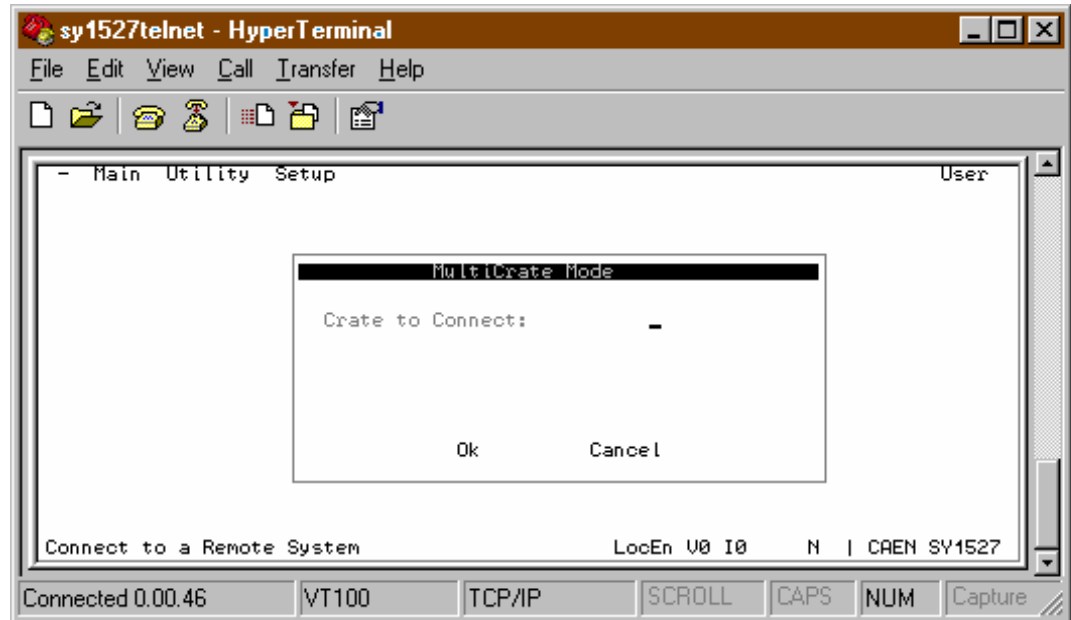

Fig.7.10 – Connect Window

7.1.12 The MAIN Menu: Logout

As **Logout** is entered, the program goes back to the **Welcome Screen**. Refer to Fig. 7.3, p.45 for the layout of the **Welcome Screen**.

7.1.13 The GROUPS Menu and relevant commands

The **Groups Menu** allows to create up to 15 different custom groups of channels (**Group 01** through **Group 15**), containing a subset of the channels available. By default, the **Group 00** is the group containing all the channels and cannot be edited.

The **Groups** menu gives access to:

- **Group mode** toggle command,
- **Add Channels**,
- **Remove Channels**,
- **Group 00** through **Group 15** windows.

In order to create a new group, follow this procedure:

1. Select the **Group** you want to create (one among **Group 01** through **Group 15**) in the pop-up **Groups Menu**: if the group you selected already exists, the screen will display the Channels Window for the selected group; if it does not yet exist, the software will directly display the **Add Channels** pop-up window (Fig. 7.11);
2. Select **Add Channels** (if not yet displayed) from the **Groups Menu**: a pop-up window will show a list containing all the channels which are NOT included in the current group;
3. Select the channel you want to add to the group, if any, and press SPACEBAR to select it;
4. Repeat point 3. for each channel you want to add to the current group;
5. Press TAB key and select OK or CANCEL to confirm the channel selection you have made or to cancel it;
6. Select **Remove Channels Window** (Fig. 7.12): a pop-up window will show a list containing all the channels which are already included in the current group;
7. Select the channel you want to remove from the group, if any, and press SPACEBAR to select it;
8. Repeat point 6. for each channel you want to remove from the current group;
9. Press TAB key and select OK or CANCEL to confirm the channel selection you have made or to cancel it.

Please note that both the **Add Channels** and **Remove Channels** affect only the group which is displayed on the screen.

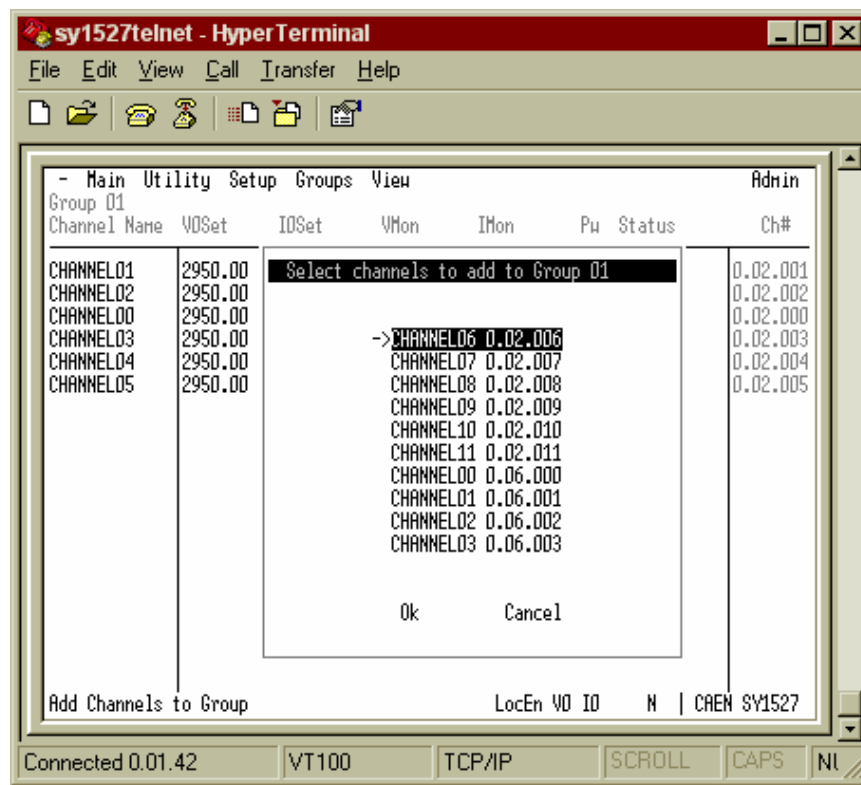

Fig. 7.11 – Add Channels pop-up Window

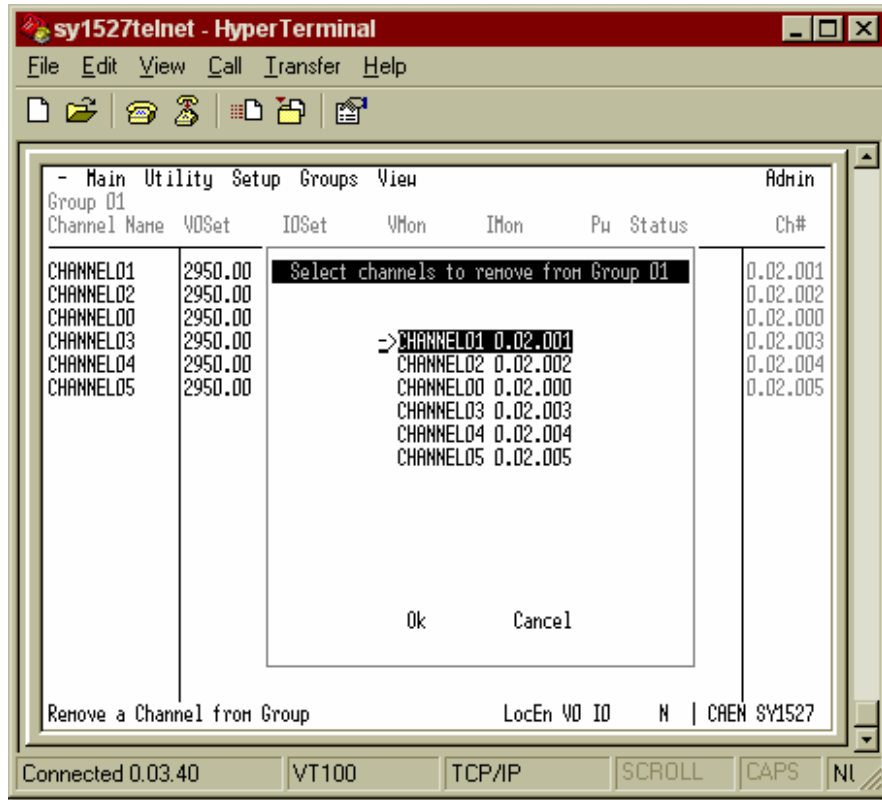

Fig. 7.12 – Remove Channels pop-up Window

Group Mode is a toggle command which allows to operate in Group Mode, i.e., if the **Group Mode** option is selected, any operation performed on one channel in the **Channels Window** will affect all the channels of the group displayed in the window.

For example, let the **Group 01** be displayed in the **Channels Window**; if the user selects the **Group Mode** option from the **View Menu** and then change the V0SET parameter of the channel 'ChName', the V0SET parameters of all the channels of the Group 03 will be automatically set to the new value set for the channel 'ChName' (refer to Fig. 7.13).

N.B.: Group Mode management is not possible with EASY3000 and EASY4000 Power Supply boards.

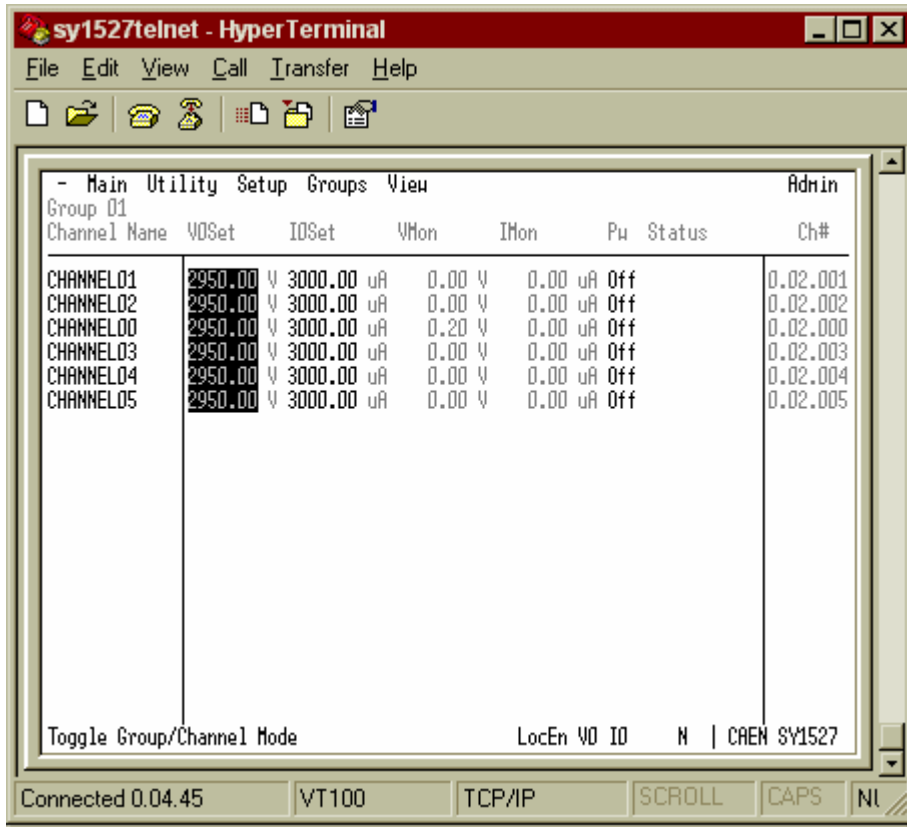

Fig. 7.13 – Group mode Window

7.1.14 The VIEW Menu and relevant commands

The **View Menu** allows to customise the type and position of the parameters to be displayed in the **Channels Window**.

The **View Menu** gives access to the following toggle command:

- **Parameters** toggle command.

Parameters is a toggle command which allows to customise the layout of the Channel Window.

7.1.15 The UTILITY Menu: Kill

The **Kill** command has the same function of the KILL command described in § 4.2.6, p.26.

As **Kill** is selected, the pop-up window shown in Fig. 7.14 will appear: if you want to forward the KILL command, select the YES button and press ENTER.

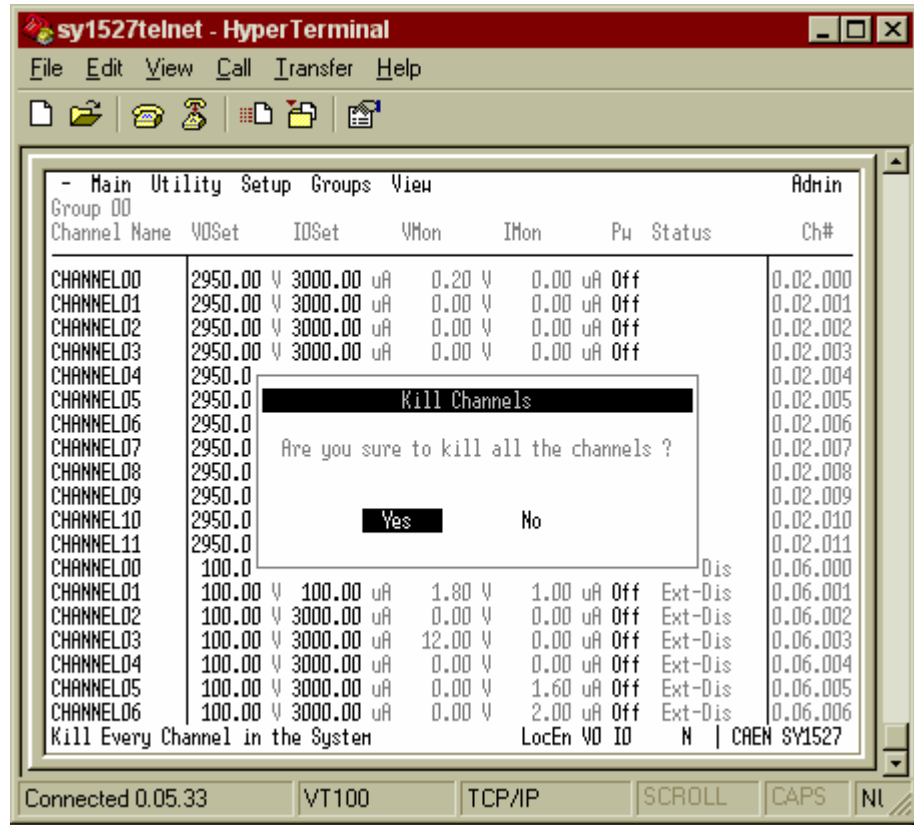

Fig. 7.14 – Kill pop-up Window

7.1.16 The UTILITY Menu: Clear Alarm

The **Clear Alarm** command allows to remove all the alarm conditions which appeared in the Channel Status column of the Channel Window (refer to § 7.1.9, p.49).

This operation automatically resets the alarm conditions without requiring the power on of the channels. Moreover, it sets the TRIP counter again to its initial programmed value, so that the TRIP counter will start again from the programmed TRIP value as soon as another Over Current condition occurs. Refer to § 4.4.13, p.33 for further details.

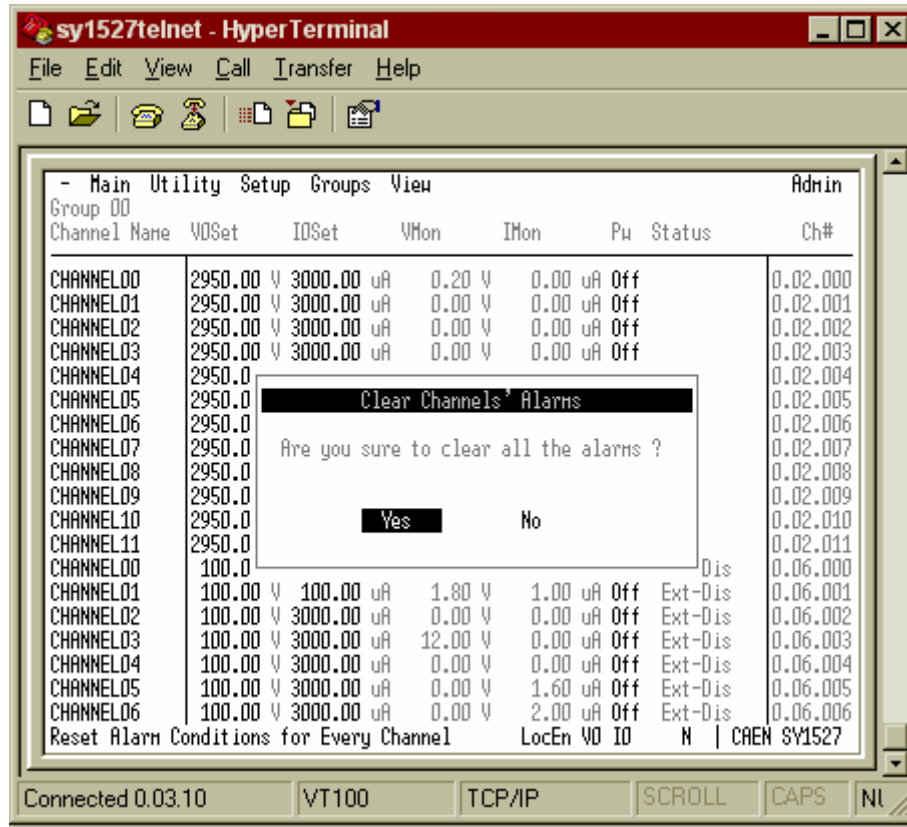

Fig. 7.15 – Clear Alarm pop-up Window

7.1.17 The UTILITY Menu: Status

This command allows to define the condition to assert the GEN signal and light up the relevant LED (see § 4.3.7).

Fig. 7.16 shows the pop-up window containing a list of quantities which allow to define the condition for asserting the GEN signal according to the following relation:

$$\text{GEN} = \text{ENABLE} \wedge (\text{OVC} \vee \text{OVV} \vee \text{UNV} \vee \text{ALWAYS}) .$$

To select any of these quantities insert an asterisk in the relevant field by using the arrows. Then select OK and press ENTER.

ENABLE corresponds to enable the GEN signal generation and consequently must be always selected in order to assert the GEN signal.

OVC, **OVV**, and **UNV**, are signals for system status monitoring (refer to § 4.3.1, 4.3.2, 4.3.3, p.28). If one or more of them are selected and the **ENABLE** is selected too, the GEN signal is asserted TRUE at the occurrence of any of the selected conditions.

ALWAYS allows to assert the GEN signal TRUE anyway. If it is selected and the **ENABLE** is selected too, it asserts the GEN signal TRUE anyway, independently from the status of the other signals mentioned above (OVC, OVV and UNV).

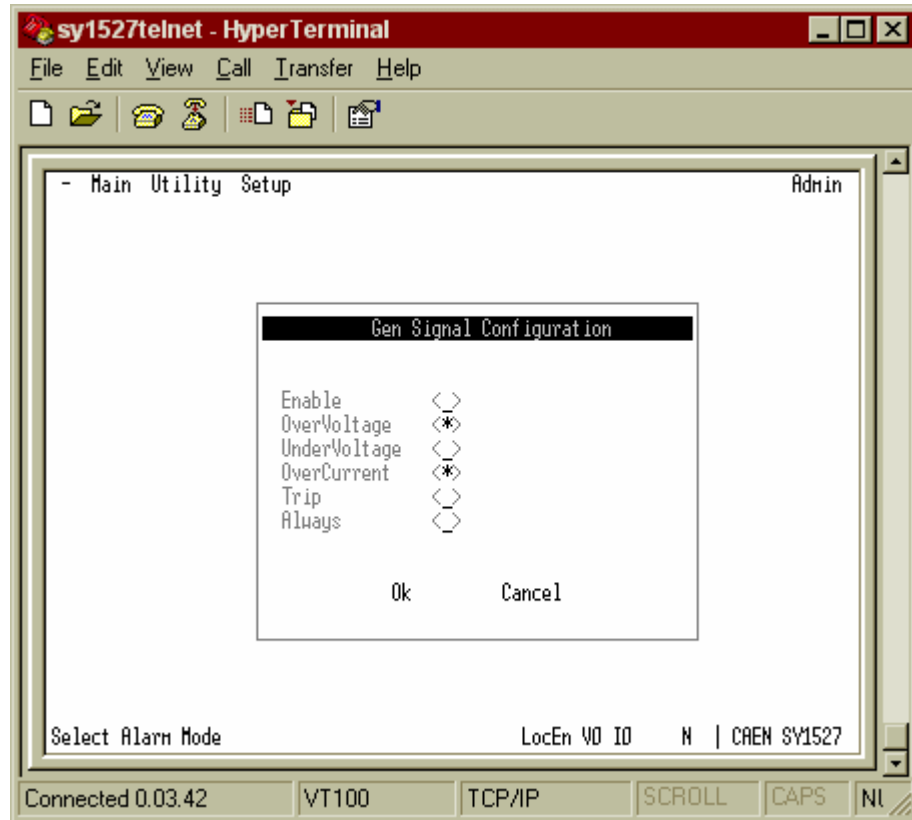

Fig. 7.16 – Status pop-up Window

7.1.18 The UTILITY Menu: Format

The **Format** command allows to format the flash memory of the system.

In particular, it erases:

- all system settings;
- board firmware.

To format the flash memory, select YES and press ENTER (refer to Fig. 7.17).

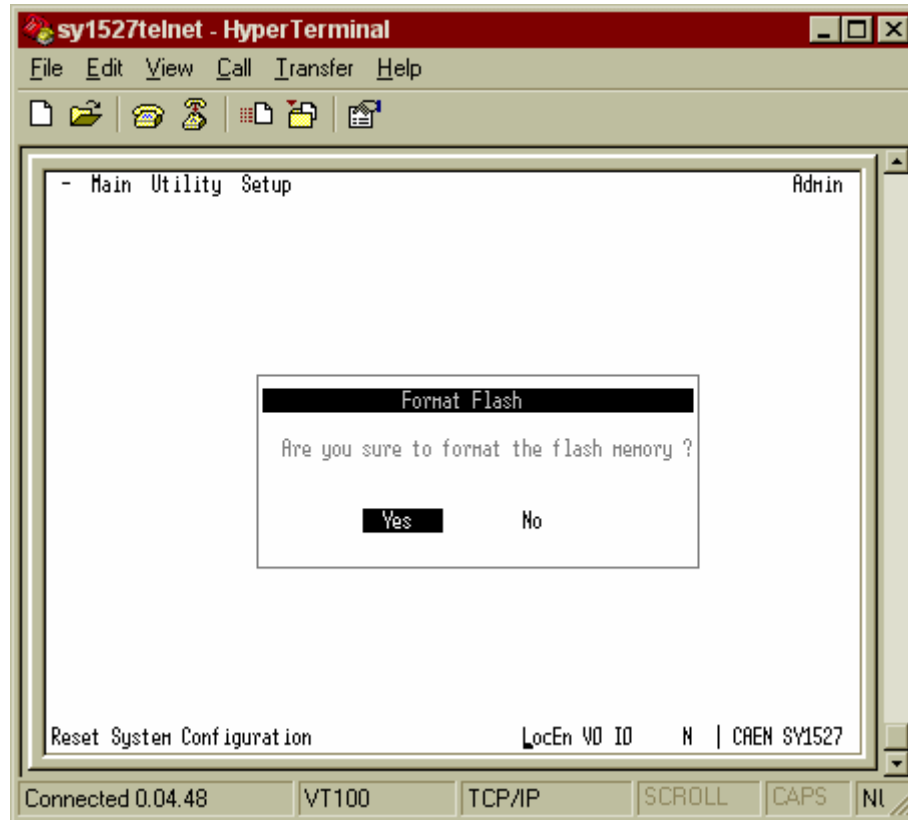

Fig. 7.17 – Format pop-up Window

7.1.19 The UTILITY Menu: Board Upgrade

This command opens the Board Upgrade pop-up window (Fig. 7.18) which allows to upgrade the firmware of the boards plugged into the crate.

The window can be divided into two areas the upper one where there is the list of files present in the system flash memory, and the lower one where there is a list of the commands available.

If there are no files in the flash memory, i.e. the upper list is empty, the files can be retrieved from a computer connected to the system via RS232 by using the terminal emulator program or a TFTP (Trivial File Transfer Protocol) Server Software³.

The standard filename format from the factory for board firmware upgrade is as follows:

Board Firmware Filename = [boardname] . Imn

Where [boardname] is the board model and Imn is the Firmware Release I.mn. For example, the file containing the Firmware Release 1.01 of the board Mod. A1734 will be named at the factory:

A1734.101

³ The TFTP Server is usually available on Unix workstations. In case of PCs with Windows 9x/NT, there are various shareware programs available on Internet, e.g. the program *Pumpkin* by the KLEVER GROUP INC. (www.klever.net).

In order to add a file for board firmware upgrading in the system flash memory via RS232, follow this procedure:

1. check that the system is connected correctly via RS232 to a computer running a terminal emulator program;
2. enter the **Utility menu → Board Upgrade → Add File (via RS232)** of the SY1527 Software User Interface from the terminal emulator program: a pop up window will ask for the filename to add to the flash memory;
3. type the **Filename** you want to assign to the file you will load in the flash memory, select OK and press ENTER (the *status Bar* at the bottom of the window will display a *Waiting data...* message);
4. select **Transfer → Send Text File** command in the Command Bar of the terminal emulator program (these commands are an example referring to the Hyperterminal of Win9x), browse in the directories and select the file you want to load in the flash memory; then click **Open** (the *Status Bar* will display a *Downloading ...* message and finally *Download completed.*);

N.B.: if the user tries to add a file when the SY1527 system is operating in standalone configuration or if it is connected to a computer via TCP/IP protocol or H.S. CAENET instead of RS232, the software will show an error message (*WARNING: only available via RS232 Terminal connection*).

In order to add a file in the system flash memory via TFTP, follow this procedure:

1. check if the system is connected via TCP/IP protocol to a computer able to run a TFTP (Trivial File Transfer Protocol) Server Software and configured properly;
2. run the TFTP Server Software and select the directory containing the file you want to add;
3. enter the **Utility menu → Board Upgrade → Add File (via TFTP)** of the SY1527 Software User Interface (you can also be running the SY1527 software also via a type of connection different from the TCP/IP protocol): a pop up window will ask for the filename to add to the flash memory;
4. type the **Filename** you want to load in the flash memory (in this case the filename must be the real filename of the file you want to add), select OK and press ENTER;
5. type the **IP Address** of the computer where the file is, select OK and press ENTER (the *Status Bar* at the bottom of the window will display a *Downloading ...* message and finally *Download completed*).

After you followed one of the two procedures, the new file is displayed in the list in the upper area of the Board Upgrade window. the file dimensions as well are shown beside the filename. It is possible to load up to three files in the system flash memory.

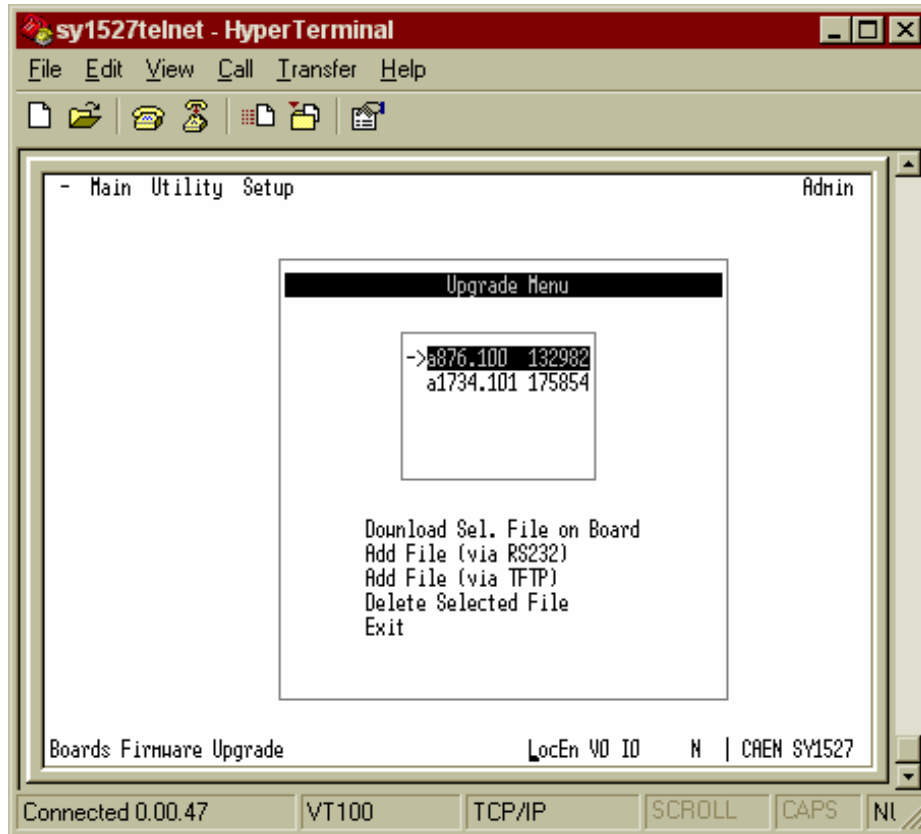

Fig. 7.18 – Board Upgrade pop-up Window

In order to upgrade the firmware of the boards, it is now necessary to download the firmware on the board by using the **Download Selected File on Board** command. In order to upgrade the firmware on the board, follow these steps:

1. select the file you want to download by means of the arrows in the upper area of the Board Upgrade window;
2. Select the **Download Selected File on Board** command by means of the TAB key and then press enter: as this command is entered, the software will ask you for the slot where to download the firmware;
3. type the number of the **Slot** where the board you want to upgrade is plugged into, select OK and press ENTER: some messages displayed at the bottom of the window will indicate the on-going operations.

To erase a file from the flash memory select the **Delete Selected File** command and press ENTER.

To exit the Board Upgrade window select the **Exit** command and press ENTER.

7.1.20 The UTILITY Menu: Remote Board Upgrade

In a similar way to the Board Upgrade, it is possible to upgrade the Remote boards handled by the A1676A Branch Controller (running firmware rev. 2.03 or later). Select "Remote Board Upgrade" in the Utility Menu; once the new firmware is loaded into the Flash memory (see § 7.1.19), select "Download Sel. File on Board". At this point the following window opens:

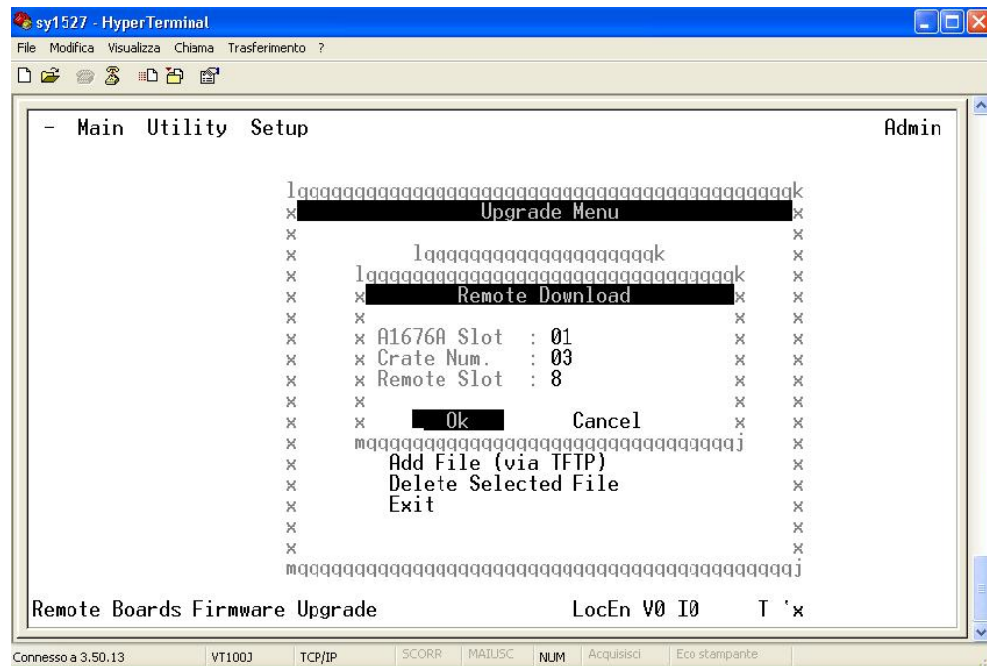

Fig. 7.19 – Remote Board Upgrade pop-up Window

Type in the Remote Download window the “parameters” of the board to be upgraded:

1. *A1676A slot* = the slot where the A1676A (which MUST run firmware rev. 2.03 or later), which handles the board to be upgraded, is plugged
2. *Remote Crate Number* = the number of the remote crate where the the board to be upgraded is plugged
3. *Remote Slot* = the number of the slot in the remote crate where the the board to be upgraded is plugged

To exit the Board Upgrade window select the **Exit** command and press ENTER.

IMPORTANT: This feature is implemented on SY1527 Firmware Rev. 2.01.00 and later.
For further info, see the A1676A User's manual.

7.1.21 **The UTILITY Menu: System Upgrade**

In the system permanent memory there is always a *running image* which is that currently in use. However, a further image, called *stored image*, can be stored in the permanent memory as a spare image.

This command opens the System Upgrade pop-up window (Fig. 7.20) which allows to memorise an image as *stored image* in the permanent memory and then to upgrade the firmware of the system by the Upgrade Running Image command.

The window can be divided into two areas the upper one where there is the *stored image* (if any) presently loaded in the system flash memory, and the lower one where there is a list of commands.

If the upper list is empty, the file can be retrieved from a computer connected to the system via TCP/IP protocol by using a TFTP (Trivial File Transfer Protocol) Server Software⁴.

The standard image file format from the factory for system firmware upgrade is as follows:

System Firmware Filename = SY1527 - [software version] . bin

Where [software version] is the number of software version separated by hyphens. For example, the file containing the System Firmware for the Software Version x.yy.zz will be named at the factory:

SY1527-x-yy-zz.bin

In order to add a image file in the system flash memory via TFTP, follow this procedure:

1. check if the system is connected via TCP/IP protocol to a computer able to run a TFTP (Trivial File Transfer Protocol) Server Software and configured properly;
2. run the TFTP Server Software and select the directory containing the image file you want to add;
3. enter the **Utility menu** → **System Upgrade** → **Download Image via TFTP** of the SY1527 Software User Interface (you can be running the SY1527 software also via a type of connection different from the TCP/IP protocol): a pop up window will ask for the image filename to add to the flash memory;
4. type the **Filename** you want to load in the flash memory (the filename must be the real filename of the file you want to add), select OK and press ENTER;
5. type the **IP Address** of the computer where the image file is, select OK and press ENTER (the *status Bar* at the bottom of the window will display a *Downloading ...* message and finally *Download completed*).

Now a image file is displayed in the window together with its dimensions and checksum. It is possible to load only one file in the system flash memory for system firmware upgrading.

⁴ The TFTP Server is usually available on Unix workstations. In case of PCs with Windows 9x/NT, there are various shareware programs available on Internet, e.g. the program *Pumpkin* by the KLEVER GROUP INC. (www.klever.net).

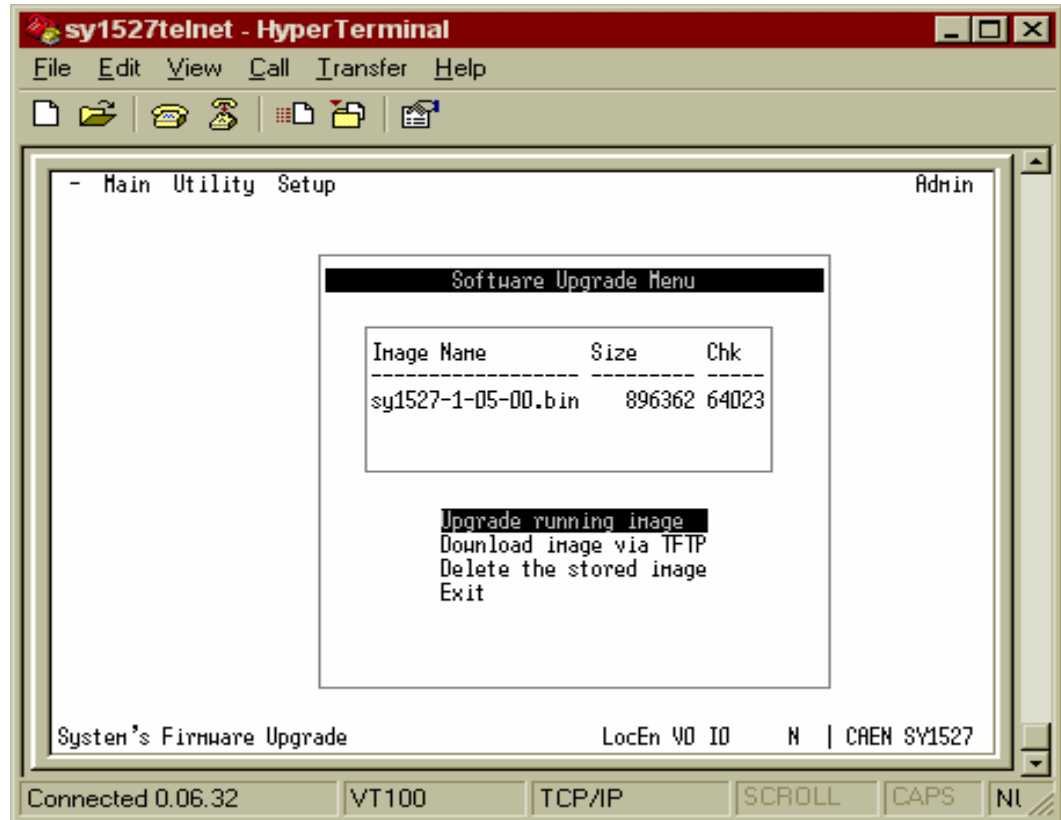

Fig. 7.20 – System Upgrade pop-up Window

In order to upgrade the system firmware, follow these steps:

6. Select the **Upgrade Running Image** command by means of the TAB key and then press ENTER: as this command is entered, the system will be automatically reset and the currently running image file will be substituted by the stored image file displayed in the window;

To erase the file from the flash memory select the **Delete the stored image** command and press ENTER.

To exit the System Upgrade window select the **Exit** command and press ENTER.



WARNING: IT IS NOT POSSIBLE TO UPGRADE SYSTEMS RUNNING FIRMWARE REV. 2.X TO FIRMWARE REV. 3.X (NEITHER TO DOWNGRADE FROM 3.X TO 2.X).

ANY ATTEMPT TO EXECUTE A NON-ALLOWED UP/DOWNGRADE WILL STOP THE SYSTEM OPERATION AND WILL REQUIRE AN OUT-OF-WARRANTY REPAIR BY CAEN S.P.A. PERSONNEL.

IF YOU OWN SYSTEMS RUNNING FIRMWARE REV. 2.X AND WISH TO UPGRADE YOUR EQUIPMENT TO FIRMWARE REV. 3.X , PLEASE CONTACT CAEN S.P.A. TO:

info@caen.it

7.1.21.1 System Upgrade with *PumpKIN* by the KLEVER GROUP INC.

In order to add a image file in the system flash memory on a PC with Windows 9x/NT via TFTP, follow this procedure:

1. Download (from www.klever.net), install and run the pumpkin.exe program:

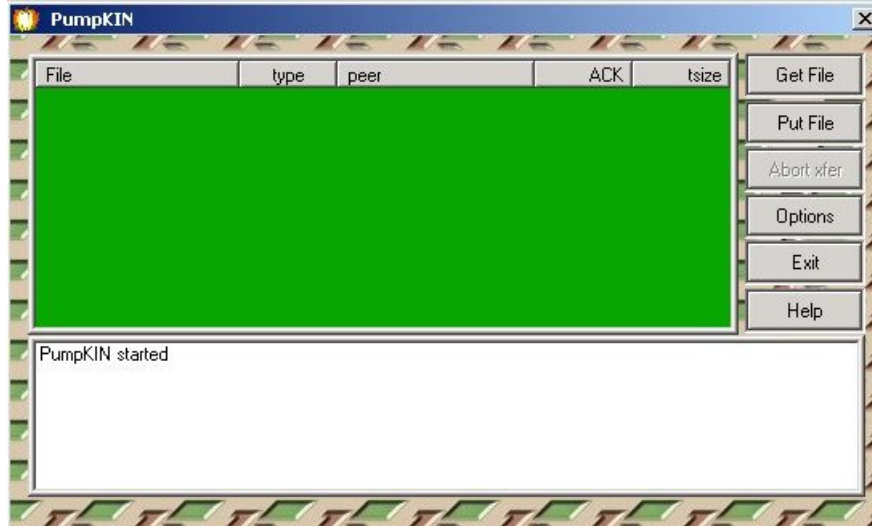

Fig. 7.21 – PumpKIN Menu Window

2. Select [Options] and browse the folder where the image file resides with the following selections, then press [OK]:

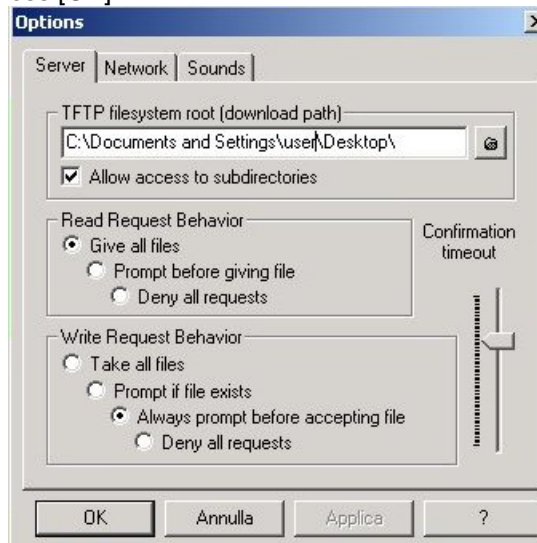

Fig. 7.22 – PumpKIN Options Window

3. Connect to the System by using, for example: PuTTY, HyperTerminal etc.:

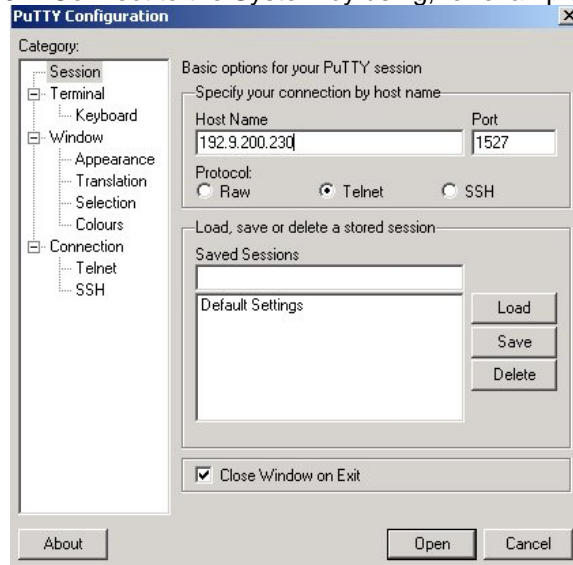

Fig. 7.23 – Connection via HyperTerminal

4. Perform the System Log In:

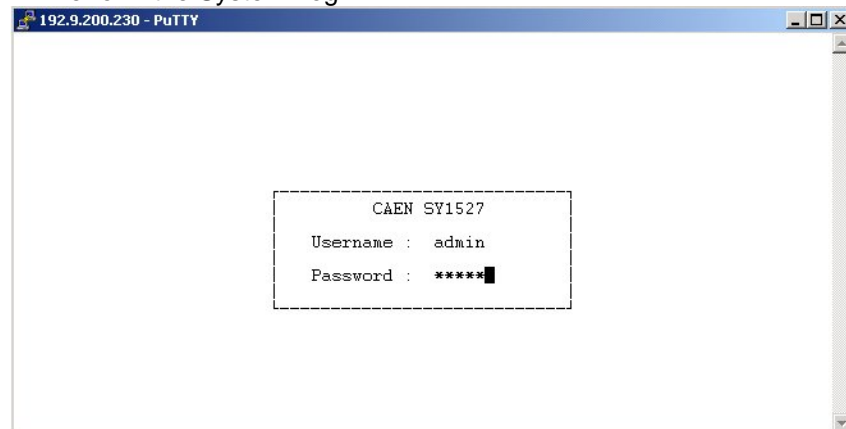

Fig. 7.24 – System Log In

5. Select the System Upgrade option from the Utility Menu:

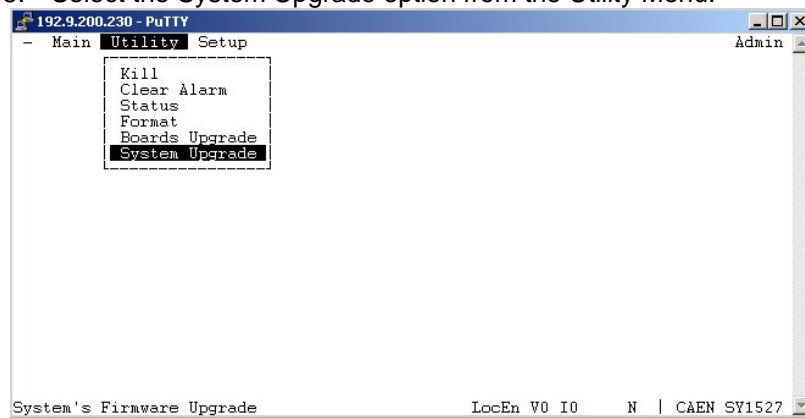

Fig. 7.25 – The Utility Menu/1

6. Type the image file name (for example: sy1527-1-14-04.bin), press OK then Download image via TFTP:

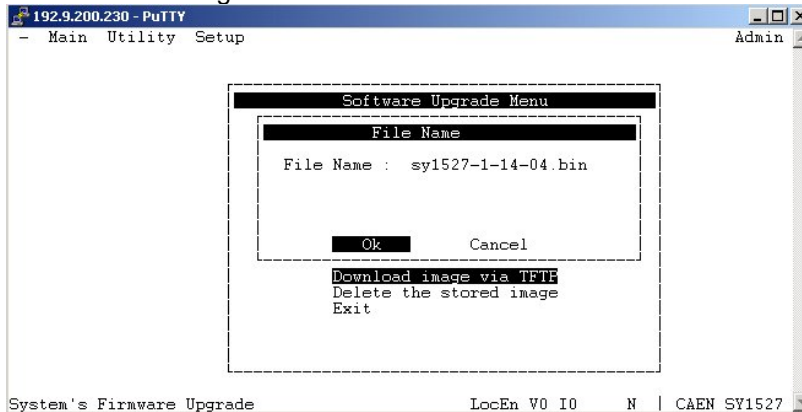

Fig. 7.26 – The Utility Menu/2

7. Now type the IP Address of the PC which is running PumpKIN:

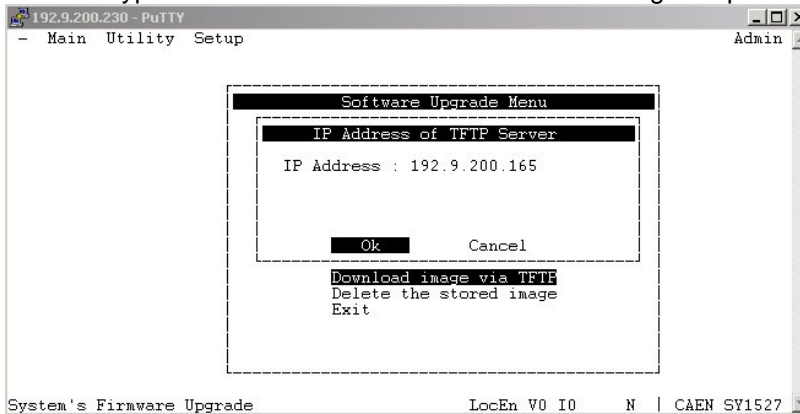

Fig. 7.27 – The Utility Menu/3

8. The System Upgrade is now successfully completed:

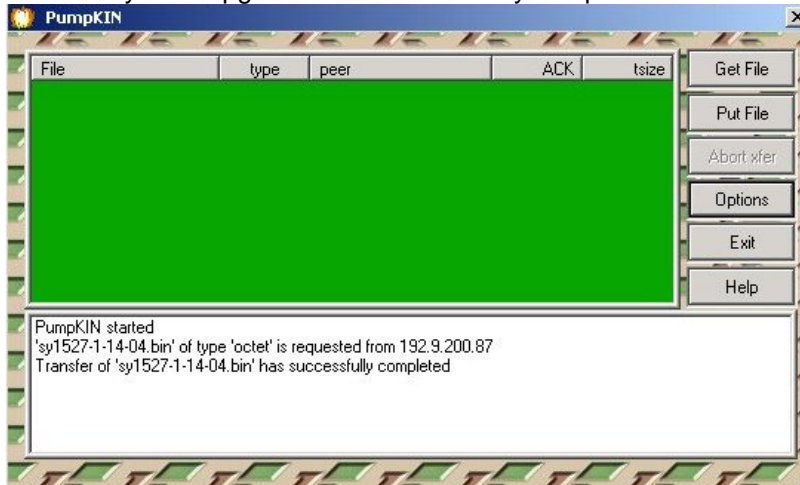

Fig. 7.28 – PumpKIN Transfer confirmation

7.1.22 **The SETUP Menu: Reset Flag**

This command opens the **Reset Flag** pop-up window (Fig. 7.29) which allows to enable the different reset conditions and to assert TRUE the RESET FLAG output signal (and relevant LED alight) accordingly.

Specifically, the RESET FLAG output signal can be asserted TRUE at the occurrence of one of the following types of resets:

- **PC Failure Self Reset**, i.e. a reset of the CPU section due to a failure;
- **PC User Software Reset**, i.e. an auto-reset of the CPU section due to a command forwarded by the user (not yet implemented);
- **PC Front Panel Reset**, i.e. an reset of the CPU section sent via front panel;
- **BP User Software Reset**, i.e. an auto-reset of the board section due to a command forwarded by the user (not yet implemented);
- **BP Front Panel Reset**, i.e. a reset of the board section sent via front panel;
- **BP WatchDog**, i.e. a reset of the board section due to a firmware control failure.

If more than one reset types are selected, the RESET FLAG signal will be asserted at the first occurrence of any of them.

This window allows also to enable the relevant reset condition, i.e. if a condition is tagged with the asterisk it is enabled; if it is not tagged, it is disabled. **For example, if the PC front panel reset is not tagged with the asterisk, a signal sent through the front panel connector does not reset the CPU.**

Default setting is **PC Front Panel Reset** and **BP Front Panel Reset** enabled.

To select one or more of these conditions, move through the rows with the Up/Down arrow keys, tag the chosen conditions with the asterisk by the Left/Right arrow keys and then select OK and press ENTER.

Default settings are shown in the figure below: these correspond to assert TRUE the RESET FLAG output signal on the occurrence of a CPU RESET (PC Reset) from the front panel and on the occurrence of a boards RESET (BP Reset) from the front panel. For details on the RESET signal please refer to § 4.2.7.

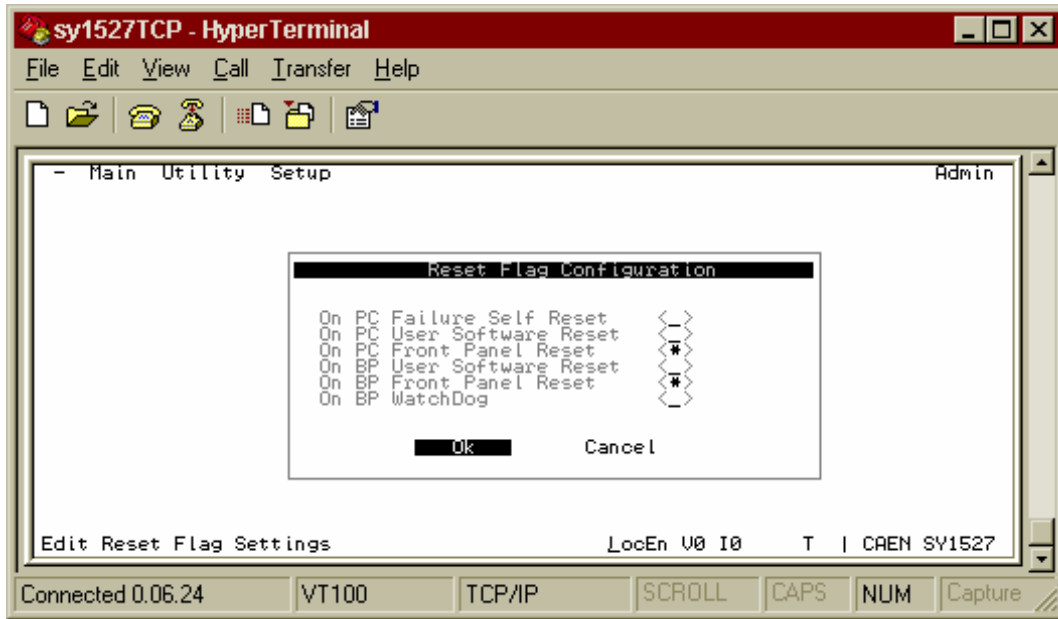

Fig. 7.29 – Reset Flag pop-up Window

7.1.23 The SETUP Menu: Communications

From the **Communications** pop-up window it is possible to access to the settings of the interfaces installed on the system.

In particular, these are:

- **RS232 settings,**
- **TCP/IP settings,**
- **CAENET settings.**

These menus are accessible only if the current session was started with an Administrator profile login. User and Guest profiles are not allowed to change interface settings.

The settings available in the **RS232 settings** pop-up window are as follows:

- Baud rate,
- Parity,
- Character Length,
- Number of stop bits
- Flow control.

Default settings are listed in Table 6.1.

The settings available in the **TCP/IP settings** pop-up window are as follows:

- IP address,
- IP Net Mask,
- Gateway.

Default settings are listed in Table 6.2.

The setting available in the **CAENET settings** pop-up window is:

- Crate Number.

The crate number is the identification number assigned to the crate when belonging to a daisy-chain.

Default settings are listed in Table 6.4, p.40.

7.1.24 **The SETUP Menu: Security**

The Security allows the management of the passwords of the System.

The factory settings allow to access the System under the following profiles:

<i>User ID</i>	<i>Password</i>	<i>Level</i>
admin	admin	Admin
user	user	User
guest	guest	Guest
1527	1527	Guest

The Admin level allows to access all the settings of the system, of the boards and of the channels; moreover it allows to upgrade the system software and the board firmware.

The User and Guest levels allow to access all the settings of the boards and of the channels.

Moreover the Admin level allows to:

Create new lower level (User and Guest) users (up to 15 users);

Remove lower level users;

Change the admin password;

Execute the Format command, which restores the four factory-set users, with the related passwords (and deletes all the other ones).

Lower levels (User and Guest) can only change their own passwords.

The same effect of the Format command can be obtained by pressing the <Esc> and <p> keys simultaneously; such operation cannot be performed remotely, but only in local connection.

7.1.25 **The SETUP Menu: Tech Info**

This pop-up window shows some technical information about system operation. Specifically:

- Number of Power Supply Units inserted into the crate and their relevant operation condition;
- Fan speed (fans 0 through 5) and their operation condition;
- AC frequency;
- Origin of the last RESET of the CPU section;
- Origin of the last RESET of the board section;
- A1528 Controller Software Release.

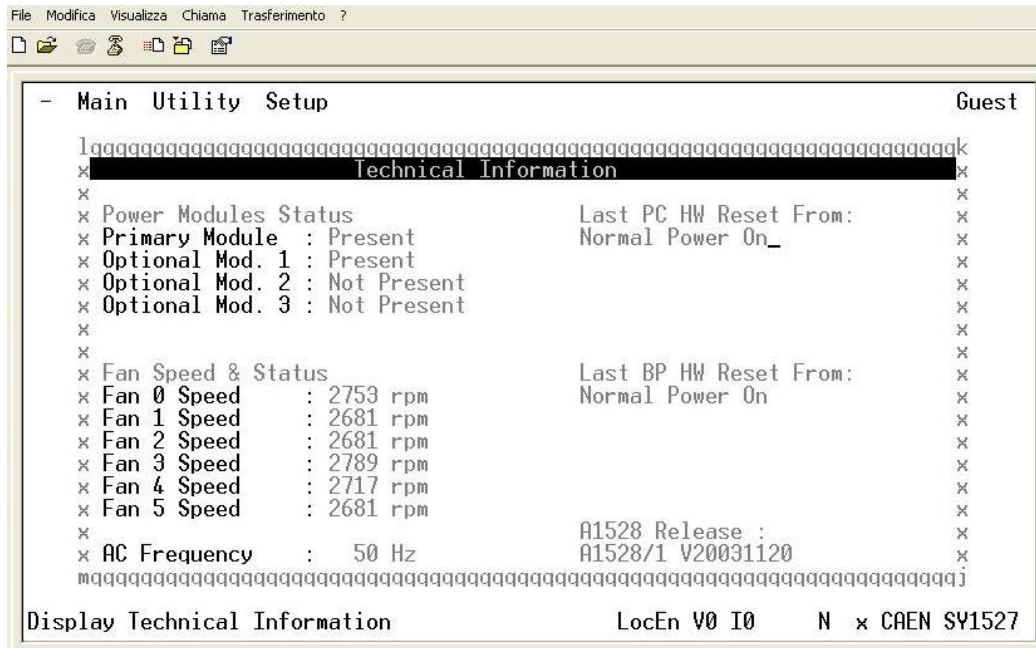

Fig. 7.30 – Tech Info pop-up Window

7.1.26 The SETUP Menu: HV Clock Conf.

This command allows the configuration of the crate as MASTER or SLAVE for the synchronisation clock **HVSYNC** (RS485 standard, 1.25 MHz) for the Power Supply Units belonging to a chain of crates. **HVSYNC** is the synchronisation clock for the Power Supply Units (RS485 standard, 1.25 MHz). It can work either as MASTER (MASTER red LED on), i.e. the synchronisation clock is internally generated and the HVSYNC connector works as output, or as SLAVE (MASTER red LED off), i.e. the synchronisation clock is externally generated and sent through the HV SYNC connector which works as input. This command allows also to enable the LOCAL NET (External CANBUS), thus allowing to handle a slave SY3527 system; this option is available only under Administrator log in level.

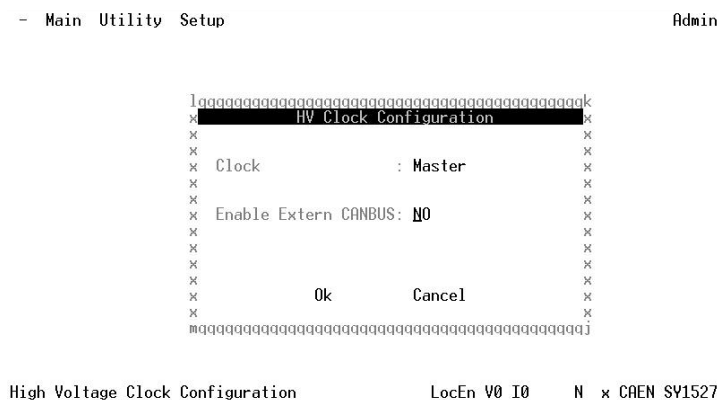

Fig. 7.31 – HV Clock Conf. Window

7.1.27 The SETUP MENU: Advanced

From the ADVANCED pop-up window it is possible to access to the advanced features of the system.

In particular these are:

- Event Mode
- Network Security

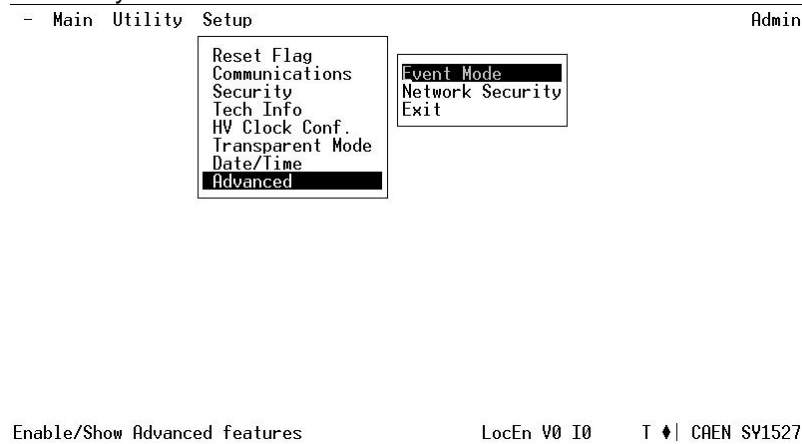

Fig. 7.32 – Advanced MENU options

These menus can be accessed only if the current session was started with an Administrator profile login. User and Guest profiles are not allowed to change interface settings.

The Event Mode window allows the Administrator to enable (or to verify) the new internal functions used to manage the Event Mode handling for the communication from the system to the client (to know more about the event managing please refer to OPCServer manual and CAENHVWrapper manual).

If the Event mode is disabled (default setting), a password is required to enable it. Once the correct password is entered, the system should be restarted in order to apply the change.

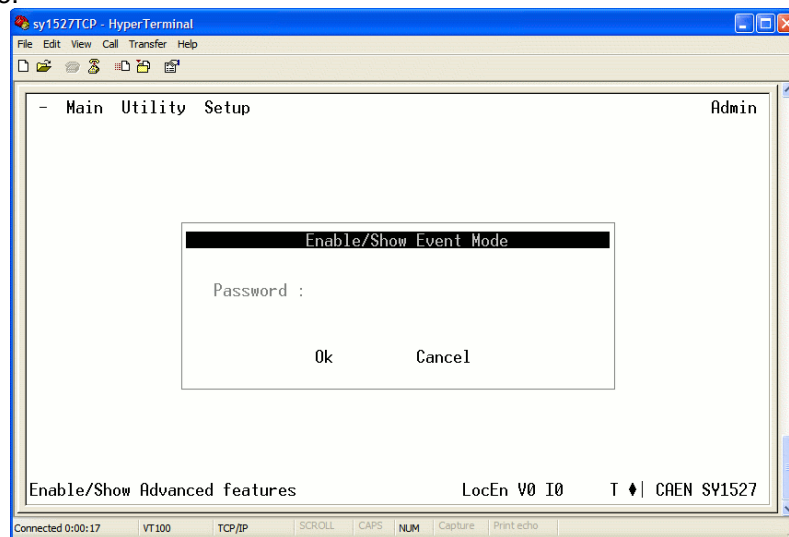

Fig. 7.33 – Event Mode Password request

If the Event mode is already enabled no further action is required. The Network Security window is not yet implemented.

7.1.27.1 Event Mode

SY1527 systems running firmware 3.x (and greater) feature the Event Mode; which is available for OPCServer and CAENHVWrapper clients. When this Mode is enabled, the power supply system provides a “real time” notification of parameter changes, instead of waiting for a client request.

7.2 Remote operation via Terminal

Remote operation via Terminal is intended as the interactive control and monitoring of one or more SY1527 systems by using a remote terminal. The remote operation via Terminal can be performed in different ways, according to the interface used to communicate with the system. Nominally, it can be achieved by:

- Using the RS232 interface to connect one SY1527 system to a VT100-like terminal or to a standard PC running a terminal emulator program;
- Using the H.S. CAENET interface to daisy-chain two or more SY1527 systems and then controlling them from a VT100-like terminal via the RS232 interface (*Multicrate Operation*);
- Using the TCP/IP protocol via Ethernet to perform a Telnet connection.

The different configurations which can be arranged for Remote Operation via Terminal are summarised in Fig. 7.34.

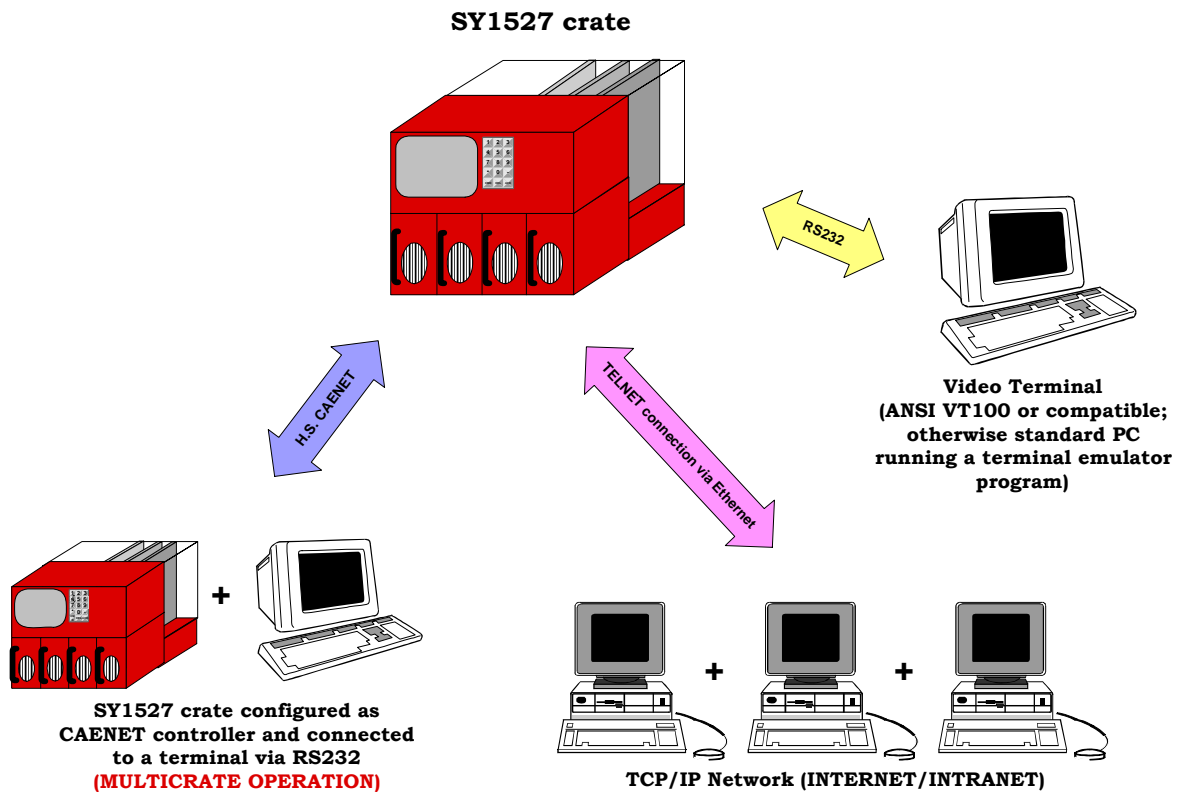

Fig. 7.34 – Remote Operation via Terminal

7.2.1 Using the RS232 interface

The RS232 interface can be used to connect one SY1527 system to a VT100-like terminal or to a standard PC running a terminal emulator program.

All installation requirements and instructions for the hardware set-up, including RS232 cable specifications and RS232 default settings, are given in the *Hardware Installation Guide* (refer to the *Hardware Installation and Set-up* Section).

All the features of the *User Interface Software* are unchanged with respect to the Standalone Operation, except for the **Welcome Screen** which is as shown in Fig. 7.35. Please refer to this section for details on the menus available and the operating instructions.

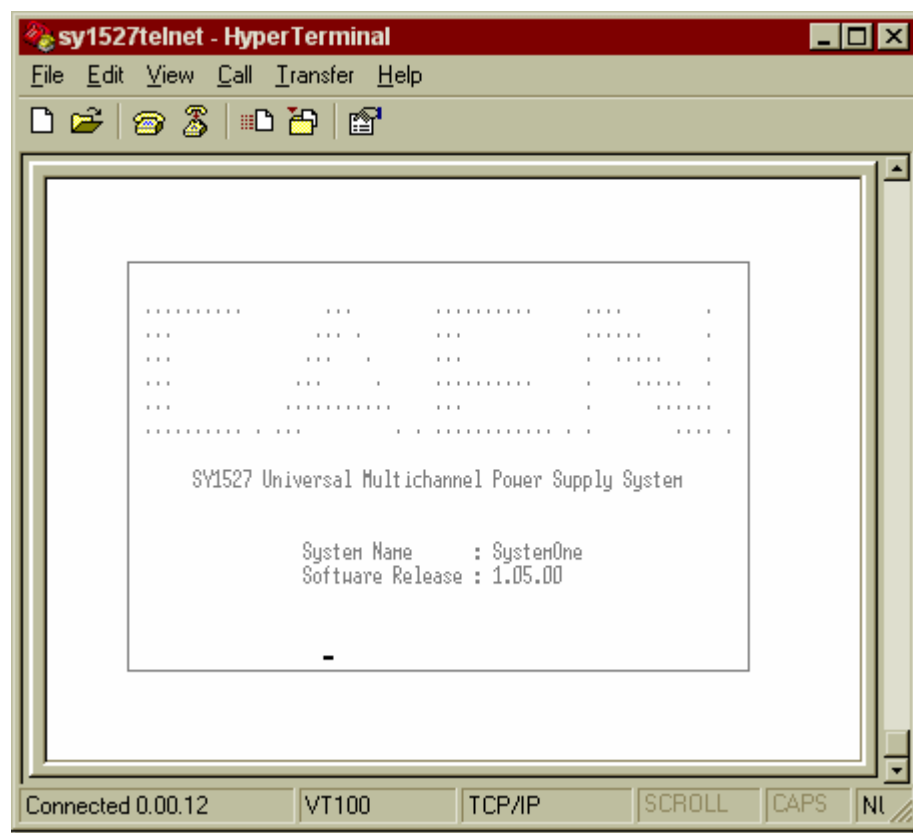

Fig. 7.35 – Welcome Screen in Terminal Operation

7.2.2 Using the H.S. CAENET (Multirate Operation)

The H.S. CAENET interface can be used to connect one or more SY1527 systems in a daisy-chain configuration and then control them from a single site. It is also possible to connect to the daisy-chain a SY527 system or a SY127 system using the H.S. CAENET interface.

The control of the chain can be performed in the following ways:

- with a SY1527 system operating in standalone configuration or in terminal operation via RS232 or Telnet;

- with a SY527 system connected to a VT100-like terminal via the commands specific of the SY527 system; actually, if an external VT100 is connected to the SY527 system, the usual *SY1527 Software User Interface* will be displayed.
- with a SY127 system equipped with a A128HS board and connected to a VT100-like terminal via the commands specific of the SY127 system; actually, if an external VT100 is connected to the SY527 system, the usual *SY1527 Software User Interface* will be displayed.

All the features of the *User Interface Software* are unchanged with respect to the Standalone Operation, except for the **Welcome Screen** which is as shown in Fig. 7.35. Please refer to the Standalone Operation section for details on the menus available and the operating instructions.

7.2.2.1 H.S. CAENET protocol

The H. S. CAENET is based on a send and receive half duplex protocol. It allows asynchronous serial transmission (1 MBaud rate) of data packets along a simple 50 Ω coaxial cable. Several devices (H. S. CAENET nodes) are able to share the same media to transmit and receive data. Each node is able to receive the serial data packet, to store it automatically in a FIFO (RX FIFO) and transmit the data contained in another FIFO (TX FIFO). Both FIFOs are 512-byte deep.

Usually, the transfers between H. S. CAENET nodes take place according to the typical Master/Slaves communication. This means that:

- there is a single Master (the H. S. CAENET Controller);
- the Slaves are daisy-chained on the network, and are identified by an address code (Crate Number);
- the H. S. CAENET Master starts the transmission, all the Slaves receive the data and only the addressed Slave accesses the serial line to transmit the data requested by the Master;
- the maximum data packet length is 512 bytes.

7.2.2.2 H.S. CAENET node address

The address of the H. S. CAENET node (Crate Number) is selectable via software (Connect command), and its value ranges from 0 to 99. In this way up to 100 crates may be controlled from a single system.

7.2.2.3 H.S. CAENET network termination

In order to avoid reflections it is necessary to terminate the H. S. CAENET line on a 50 Ω impedance. This is accomplished as follows:

- If the H.S. CAENET Controller is one of the crates, insert a 50 Ω impedance terminator in one of the two 00 type LEMO connectors (CAENET) in the last and in the first crate of the chain.
- If the H.S. CAENET Controller is a standard PC equipped with the A1303 H. S. CAENET PCI Bus Controller, insert a 50 Ω impedance terminator in one of the two 00 type LEMO connectors (CAENET) of the last crate of the chain.

7.2.2.4 H.S. CAENET multicrate operation sequence

In order to operate in multicrate operation, follow these steps:

- set a different crate number (from 0 to 99) for each system belonging to the chain;

- if the chain is controlled from a SY527 or a SY127 system connected to an external terminal, follow the procedure explained in the relevant manuals for multicrate operation;
- if the chain is controlled from a SY1527 in standalone operation or in terminal operation, enter the **Main** menu → **Connect** command and then type the crate number of the system of the chain you want to connect to;
- at this point the screen of the relevant system (i.e. the system with the crate number you have typed) will be displayed directly on the screen of the system acting as controller (MASTER) allowing for the remote control of the other system.

7.2.3 Using the TCP/IP protocol via Ethernet (Telnet Client)

The Ethernet interface can be used to connect one SY1527 system to a standard PC running a terminal emulator program (Telnet Client).

All installation requirements and instructions for the hardware set-up, including cable specifications and TCP/IP default settings, are given in the *Hardware Installation Guide* (refer to the *Hardware Installation and Set-up* Section). Refer also to § 6.2, p.39 of this guide for TCP/IP software configuration.

All the features of the *User Interface Software* are unchanged with respect to the Standalone Operation, except for the **Welcome Screen** which is as shown in Fig. 7.35. Please refer to the Standalone Operation section for details on the menus available and the operating instructions.

To operate via TCP/IP protocol, follow this procedure (the example refers to Telnet Client in Win'95; Telnet Clients are available in almost all operating systems):

1. Check if the system is connected via the Ethernet interface and if the TCP/IP protocol is configured correctly;
2. Run Telnet Client software;
3. Type the **Host name** of the system you want connect to;
4. Type the **Port: 1527**;
5. Type the **Terminal type: VT100**;
6. Select **Connect** and press ENTER.

At this point you are connected to the SY1527 system via Telnet protocol.

7.3 Remote operation via Host Computer

A newly released suite of applications guarantees CAEN power supplies' interoperability between virtually all available computing environments and communication protocols.

In the latest years OPC (OLE for Process Control) has clearly emerged as one of the most popular standards in the world of industry automation. OPC is an open interface based on the OLE/COM (now ActiveX) and DCOM technology; OPC offers "Plug&Play" connectivity between disparate control applications and hardware devices. The introduction of the OPC interface has caused the number of driver developments which hardware manufacturers implement for their components to be reduced to only one: the OPC server. On the other hand, OPC client applications (from any vendor) can

communicate with the OPC server to exchange data and control commands in a standard way. Each device property is accessed via an OPC item. An OPC server creates OPC items on behalf of an OPC client. The client's OPC items are organized in OPC groups with a hierarchical structure.

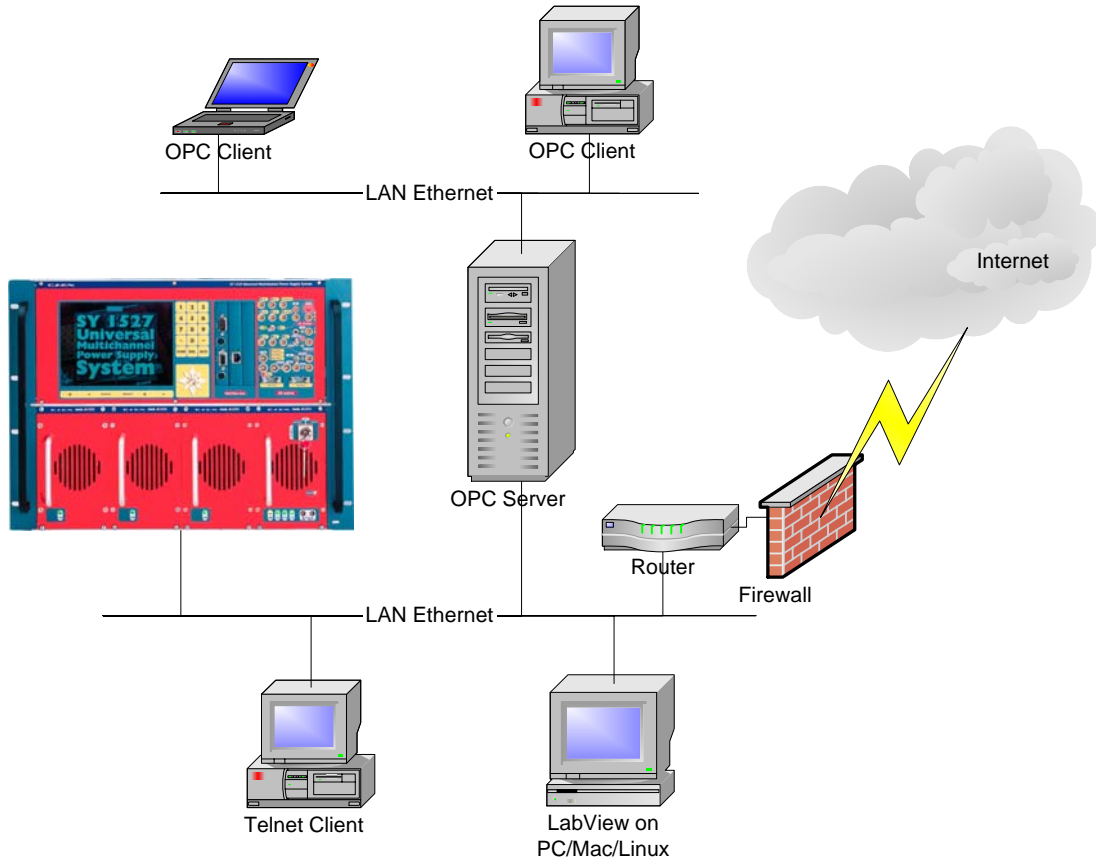

Fig. 7.36 – Remote Operation via Host Computer

CAEN, in close collaboration with CERN (IT-CO group) has developed an **OPC server** which allows powerful, flexible and yet simple control of its power supply systems, indifferently through TCP/IP or H.S. CAENET communication path by any OPC compliant client application. For further details please refer to the *OPC Server for CAEN Power Supplies User's Manual* available from <http://www.caen.it/computing>.

A C library (CAENHVWrapper) providing the software developer an unified software interface for the control of all the CAEN Power Supply Systems is also available.

8. Trip handling

If a channel trips (see § 2.2 for details about the *Trip*) due to Over Current, it can be useful to have the possibility of letting automatically other channels (which are not in Over Current) trip; this feature is implemented on most of the SY1527 PS boards.

8.1 Internal Trip

A PS Board features a number of “virtual” trip lines usually equal to half the number of its channels, so a 12 channel board features an internal 6-line Trip Bus. The channels communicate with each other through this bus: a channel can be allowed to either propagate or sense (or both propagate and sense) the *trip status* through one or more *trip lines*. This feature is achieved by writing a $2N$ -bit word (Dec. $0 \div 2^{2N} - 1$) in the relevant channel's TRIPINT parameter, where N is the number of the board's Internal Trip Bus lines. Bits $[0;N-1]$ allow the channel to sense the trip status from the corresponding lines when set to one; in the same way, bits $[N;2N-1]$ allow the channel to propagate the trip status over the Trip Bus: bit N on line 0 and so on.

For example we consider a 12 channel board with a 6-line trip bus (TRIPINT $[n]$: $0 \div 4095$): if TRIPINT $[0]$ is set to 64 (CH0 propagates the TRIP on line 0), TRIPINT $[3]$ is set to 65, TRIPINT $[4]$ is set to 65 (CH3 and CH4 both propagate and sense the TRIP on line 0) and TRIPINT $[5]$ is set to 1 (CH5 senses the TRIP on line 0), then:

- **CH3** trips whenever either **CH0** or **CH4** trips
- **CH4** trips whenever either **CH0** or **CH3** trips
- **CH5** trips whenever either **CH0** or **CH3** trips or **CH4** trips

This configuration is shown in Fig. 8.1.

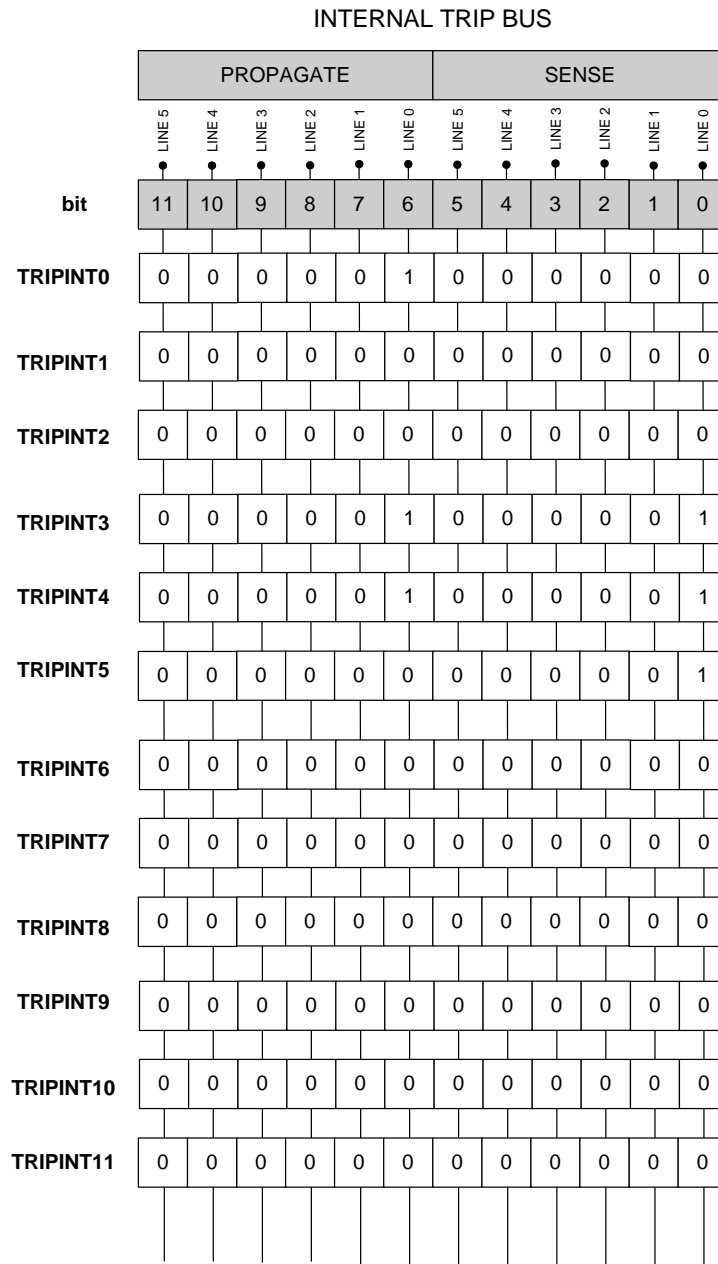

Fig. 8.1 – Trip Bus scheme

8.2 External Trip

The External Trip shares most of its features with the internal one. The number of lines is four, fixed for any kind of board, so the TRIPEXT parameter must be set in the 0÷255 range. Bits [0;3] allow the channel to sense the trip status from the corresponding lines when set to one; in the same way, bits [4;7] allow the channel to propagate the trip status over the trip bus: bit 4 on line 0 and so on. Moreover SY1527 front panel I/O connectors allow the bus control. A logic level sent to a line of the External Trip input allows to propagate the trip status over the relevant line as well as the External Trip outputs allow to monitor the bus status.

9. Secure access and User's profile management

9.1 Multilevel login profile environment

The SY1527 User Software Interface allows for a multilevel management of user's login profiles in order to protect the system from improper use.

This feature provides three different login levels: *Guest*, *User* and *Administrator*, each with a different level of access ability to the menus concerning parameter monitoring and setting. All login profiles are protected by access passwords.

The lowest access level is represented by the **Guest** profile: a user who is logged as *Guest*, will be able only to monitor system and channel parameters.

The standard access level is represented by the **User** profile: a user who is logged as *User* can monitor and set channel parameters but is not allowed to change interface settings and system parameters and to control login profiles.

The highest access level is reserved to the **Administrator** profile, which is allowed to set any kind of channel and system parameter, to change interface settings and to manage the various login profiles.

A list of the operations which can be performed by the three different types of login profiles is reported in Table 9.1.

Table 9.1 – Operations allowed in a Guest, User and Administrator login session

Type of operation	Guest session	User session	Admin. session
Channel parameter monitoring	✓	✓	✓
Channel parameter setting		✓	✓
System control in daisy-chain configuration			✓
Crate mapping	✓	✓	✓
Kill via software			✓
Clear alarm			✓
General status (GEN LED) definition		✓	✓
Flash Memory Format			✓
Firmware upgrading			✓
Reset Flag conditions			✓
Communication settings			✓
HV clock configuration			✓
Group monitoring (Group mode toggle command)	✓	✓	✓
Group setting		✓	✓
Trip handling			✓
Error handling			✓
Customising user environment		✓	✓
Multilevel Login Profile management			✓

Moreover, password protection for each channel or group of channels is also foreseen as well as the possibility of defining preferred custom environments for each single user. For details on this last feature please refer to § 7.1.24.

9.1.1 *Guest profile*

See § 7.1.24 for more details.

Username	Password
guest	guest
1527	1527

N.B.: please note that username and password typing is case sensitive!

9.1.2 **User profile**

See § 7.1.24 for more details.

Username	Password
user	User

N.B.: please note that username and password typing is case sensitive!

9.1.3 **Administrator profile**

See § 7.1.24 for more details.

Username	Password
admin	Admin

N.B.: please note that username and password typing is case sensitive!

APPENDIX A

SY1527 system Front Panel

