



Nuclear Physics Division
Fast Electronics Group

SSP Manual - HPS

Benjamin Raydo
18 August 2014

Table of Contents

Section	Title	Page
1	Introduction	3
2	Purpose of Module	3
3	Function Description	4
4	Specifications	6
5	PCB Layout View	7
6	VSCM Readout Data Format	8
7	VME Registers	11
	Document Revision History	31

1 Introduction

The Subsystem Processor (SSP) module participates in the Level 1 trigger logic for the new 12GeV experimental halls at Jefferson Lab. The SSP module receives Level 1 data streams from up to 8 crates (from the Crate Trigger Processor, CTP) for a single detector subsystem (multiple SSP modules can handle multiple detector subsystems). The SSP module processes the multiple Level 1 data streams to produce a single output stream that is passed directly to the Global Trigger Processor (GTP). Multiple SSP modules can be used to accommodate subsystems with more than 8 crates (in this case the GTP may need to perform a final computation to combine the multiple SSP streams). Figure 1a shows where this module sits along with some of the critical signals that it distributes to the various modules in the system. The Global Trigger Crate supports up to 8 SSP modules.

Figure 1a: SSP in the Global Trigger Crate

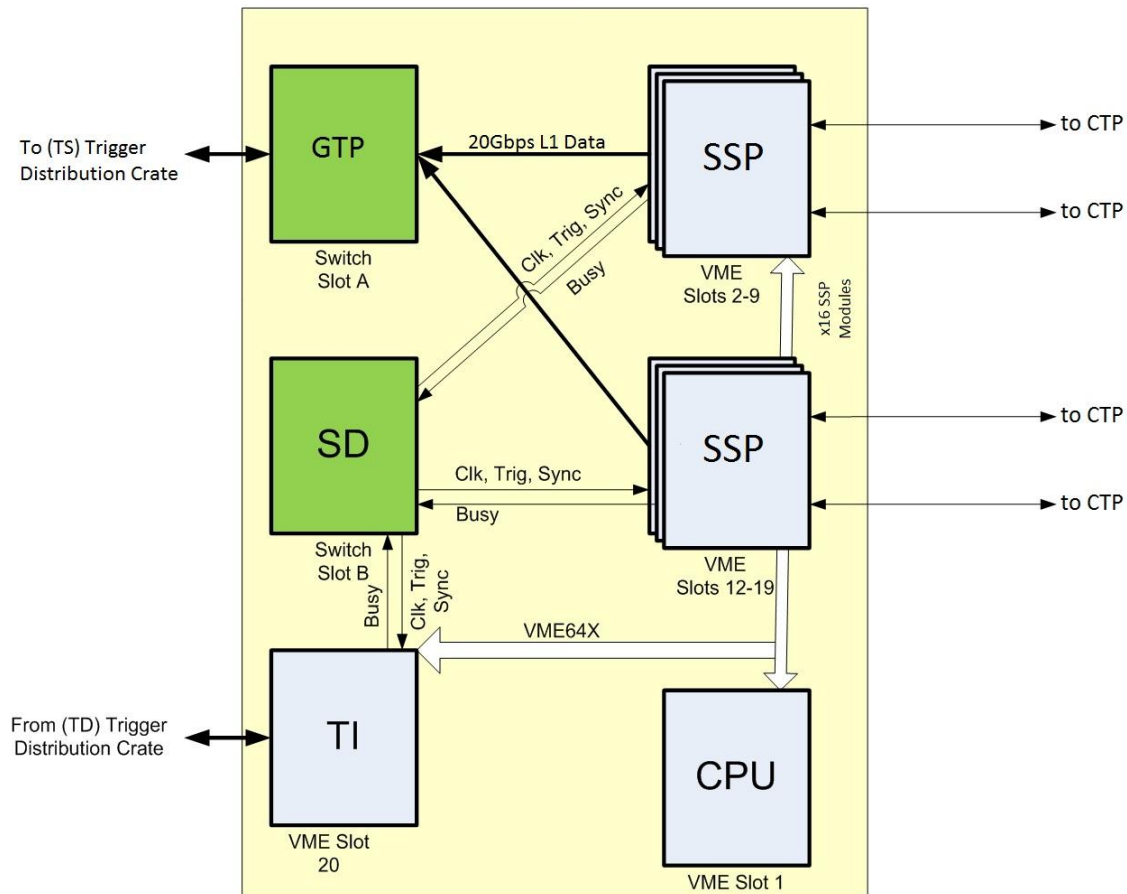

2. Purpose of the module

The SSP module communicates with the GTP and CTP using high speed serial links (2 lanes at 5Gbps for the GTP, 4 lanes at 2.5GBps for the CTP). For the CTP to SSP link a 4 lane full duplex fiber optic link is used to support the high data rate and long distance transmission (up to 150meters). The SSP to GTP link uses a 2 lane full duplex copper link over the VXS backplane. The links, after encoding, provide effectively 32bits of data every 4ns that can be used to transfer data that form the L1 trigger. The information sent on this link is specific to the experiment and detector which will be discussed in a separate document.

3. Functional Description

In Figure 3a the block diagram of the SSP is shown. The TX150T FPGA performs most of the work providing the VME interface, event building, event buffer logic, L1 trigger logic, SDRAM controller, and SerDes for fiber and VXS. In terms of the L1 trigger processing, data flows into the FPGA from the fiber transceivers and is processed then passed to the GTP through the VXS SWA port.

Figure 3a: SSP Hardware Block Diagram

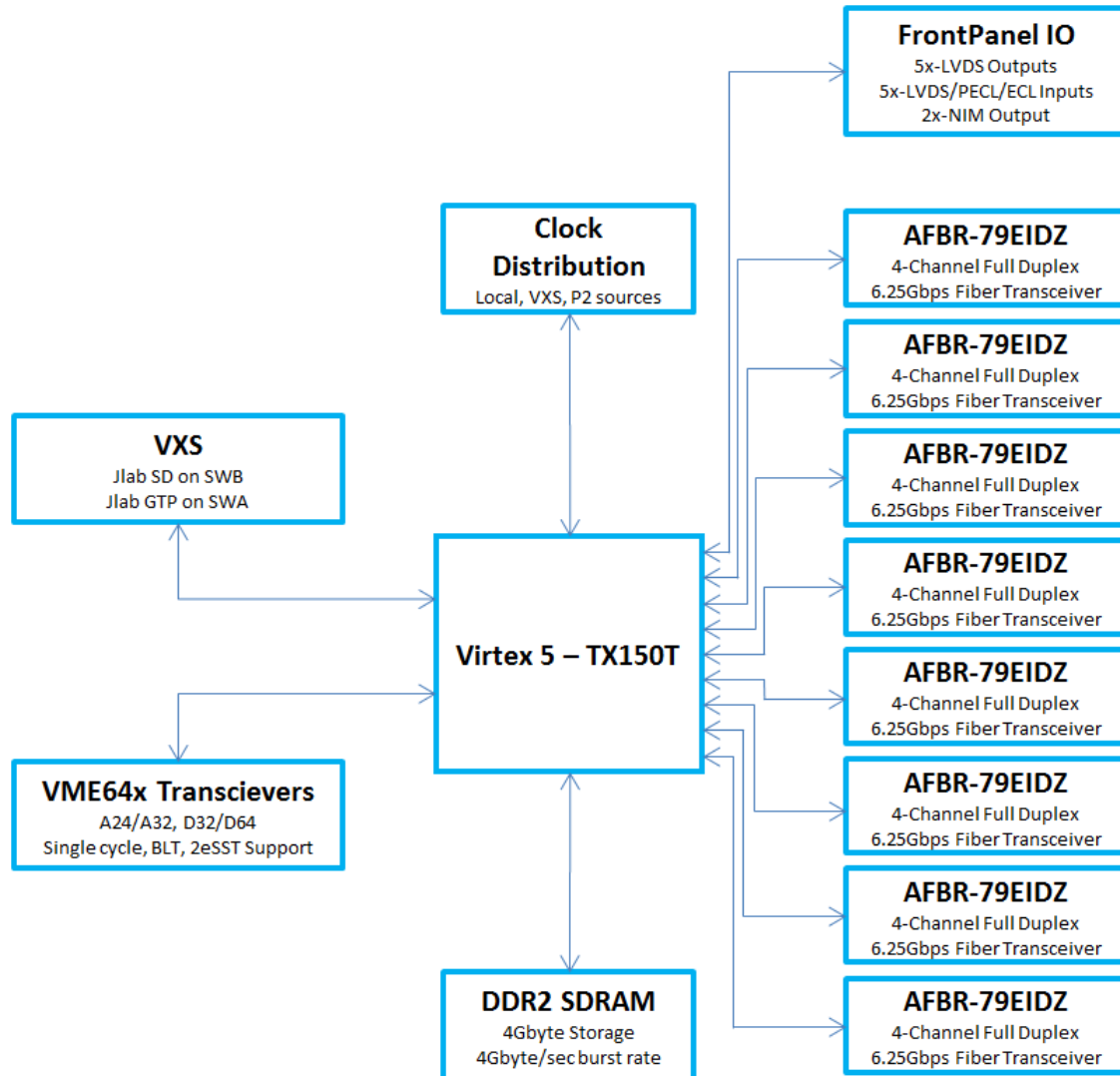

3.1 VME Interface

The VME interface is used to provide access to configuration registers on the SSP, bridge access to the fiber registers, and provide a high bandwidth interface to the CPU for event readout.

The A32 address space is dedicated to the event builder FIFO which is only used on some experiments where the SSP trigger data is used to tag each event read out. Depending on the application the FIFO exists inside the FPGA if it is relatively small or can exist in external SDRAM for very large buffers. Data can be read from the FIFO using single-cycle and block transfer VME protocols. Typically block transfer protocols will be used for event readout and specifically the 2eSST is intended for use to maximize performance. The 2eSST protocols provides nearly 200MB/s sustained transfer rate and supports the proprietary Jlab token-passing scheme that allows a single DMA operation on the CPU to transfer data from all SSP modules in a sequential manner eliminating overhead compared to individual board transfers.

The A24 address space is reserved for board register access. This address range does not support block transfer modes. Register access details will be provided in the board register description section discussed later.

3.2 VXS/Front Panel I/O

The VXS connection is used to interface to the trigger system without the need for loose cabling. This interface provides the following signals:

Signal	Description	Direction	Signal Type
Clock	250MHz System Synchronous Clock	Input	LVPECL
Trig1	L1 accept trigger bit, synchronous to clock	Input	LVPECL
Trig2	L1 accept trigger bit, synchronous to clock	Input	LVPECL
Sync	L1 synchronization bit, synchronous to clock	Input	LVPECL
Busy	Module busy signal	Output	LVTTTL
Token In	Used in VME 2eSST token passing scheme	Input	LVDS
Token Out	Used in VME 2eSST token passing scheme	Output	LVDS
Trigger Out	Module trigger bit	Output	LVDS
SD Link	Undefined serial link to SD	Output	LVDS
L1 Trigger	5Gbps per lane (4) used to generate L1 trigger	Input/Output	CML

Clock

This clock signal is derived from the TI or Trigger Distribution Crate and is used to allow synchronous operation across multiple modules within a crate as well as across multiple crates.

Trig1, Trig2

These trigger bits tell the module when to capture and store an event.

Sync

The sync signal is used to align/start board timers at the same time as other boards in the crate and system.

Busy

Busy is normal held low, but if the SSP module event buffers become close to full the busy signal can be set high to signal that the trigger supervisor must stop sending triggers so the module buffers to not overflow. If buffer an overflow happens event synchronization from this module to another is lost.

Token In/Token Out

These are used by the VME interface when performing 2eSST transfers with token passing.













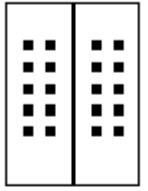





SDLink

Currently a undefined serial link to the Signal Distribution board.

L1 Trigger

This is a high speed serial link to the GTP using the Aurora streaming protocol.

4. Specifications

JLAB SSP	
 POWER DTACK	
	
	
  1	
  2	
  3	
  4	
  5	
  6	
  7	
  8	
VXS 2-9,12-19	

<p>MECHANICAL</p> <ul style="list-style-type: none"> • Single width VITA 41 Payload Module <p>HIGH SPEED SERIAL P0 INPUTS/OUTPUTS:</p> <ul style="list-style-type: none"> • 250MHz LVPECL Clock • Trig 1, Trig 2, Sync LVPECL Inputs • 4x 5Gbps Lanes to GTP (only 2 used for GTP) <p>Front Panel INPUTS/OUTPUTS:</p> <ul style="list-style-type: none"> • Ribbon-Fiber Optic transceiver <ul style="list-style-type: none"> ○ AFBR-79EIDZ • 2x NIM LEMO Outputs • 5x LVDS Outputs • 5x AnyLevel Differential Inputs (LVPECL, ECL, LVDS) <p>INDICATORS: (Front Panel)</p> <ul style="list-style-type: none"> • Power OK – Green LED • VME DTACK – Red LED • Status – Yellow LED <p>EVENT BUILDER:</p> <ul style="list-style-type: none"> • Large event FIFO • High trigger rate capable >200kHz • 8μs maximum trigger latency <p>PROGRAMMING:</p> <ul style="list-style-type: none"> • On board JTAG Port, VME <p>POWER REQUIREMENTS:</p> <ul style="list-style-type: none"> • +5.0v @ 7A Typ, 10A Peak <p>ENVIRONMENT:</p> <ul style="list-style-type: none"> • Commercial grade components (70 Celsius) • Force air cooling required: TBD
--

5. PCB Assembly View

The SSP PCB is an 18-layer impedance controlled FR-370HR stackup

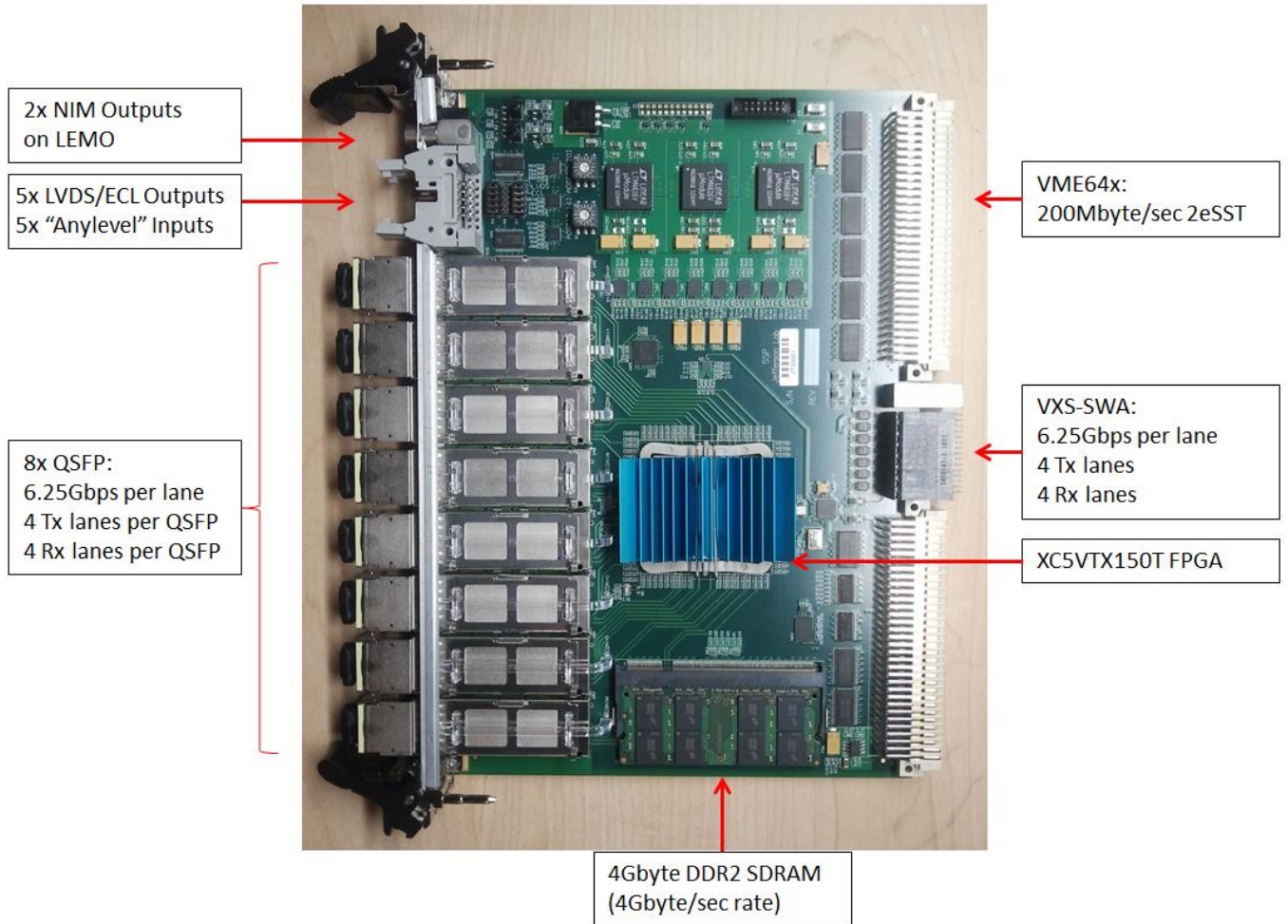

6. SSP Readout Data Format

The SSP readout data format utilizes the same encoding scheme defined for the JLAB FADC250. The word length for the readout data is 32bits. The event length is variable and depends on several factors (detector occupancy, headers, trailers, filler words).

Data Word Categories

Data words from the module are divided into two categories: Data Type Defining (bit 31 = 1) and Data Type Continuation (bit 31 = 0). Data Type Defining words contain a 4-bit data type tag (bits 30 - 27) along with a type dependent data payload (bits 26 - 0). Data Type Continuation words provide additional data payload (bits 30 - 0) for the *last defined data type*. Continuation words permit data payloads to span multiple words and allow for efficient packing of various data types spanning multiple data words. Any number of Data Type Continuation words may follow a Data Type Defining word.

Data Type List

0	Block Header
1	Block Trailer
2	Event Header
3	Trigger Time
4	HPS Cluster
5	HPS Trigger
6	Reserved
7	Reserved
8	Reserved
9	Reserved
10	Reserved
11	Reserved
12	Reserved
13	Reserved
14	Data Not Valid (empty module)
15	Filler Word (non-data)

Data Type: Block Header

Type: 0x0

Size: 1 word

Description: Indicates the beginning of a block of events. (High-speed readout of a board or a set of boards is done in blocks of events)

31	30	29	28	27	26	25	24
1	0	0	0	0	SLOTID		
23	22	21	20	19	18	17	16
SLOTID		0	0	0	0	BLOCK_NUMBER	
15	14	13	12	11	10	9	8
BLOCK_NUMBER							
7	6	5	4	3	2	1	0
BLOCK_SIZE							

BLOCK_NUMBER:

Event block number (used to align blocks when building events)

BLOCK_SIZE:

Number of events in block

SLOTID:

Slot ID (set by VME64x backplane)

Data Type: Block Trailer

Type: 0x1

Size: 1 word

Description: Indicates the end of a block of events. The data words in a block are bracketed by the block header and trailer.

31	30	29	28	27	26	25	24
1	0	0	0	1	SLOTID		
23	22	21	20	19	18	17	16
SLOTID		NUM_WORDS					
15	14	13	12	11	10	9	8
NUM_WORDS							
7	6	5	4	3	2	1	0
NUM_WORDS							

NUM_WORDS:

Total number of words in block of events

SLOTID:

Slot ID (set by VME64x backplane)

Data Type: Event Header

Type: 0x2

Size: 1 word

Description: Indicates the start of an event. The included trigger number is useful to ensure proper alignment of event fragments when building events. The 27bit trigger number (134M count) is not a limitation, as it will be used to distinguish events within event blocks, or among events that are concurrently being built or transported.

31	30	29	28	27	26	25	24
1	0	0	1	0	TRIGGER_NUMBER		
23	22	21	20	19	18	17	16
TRIGGER_NUMBER							
15	14	13	12	11	10	9	8
TRIGGER_NUMBER							
7	6	5	4	3	2	1	0
TRIGGER_NUMBER							

TRIGGER_NUMBER:

Accepted event/trigger number

Data Type: Trigger Time

Type: 0x3

Size: 2 words

Description: Time of trigger occurrence relative to the most recent global reset. The time is measured by a 48bit counter that is clocked from the 250MHz system clock. The assertion of the global reset clears the counter. The de-assertion of global reset enables counter and thus sets t=0 for the module. The trigger time is necessary to ensure system synchronization and is useful in aligning event fragments when building events.

Word 1:

31	30	29	28	27	26	25	24
1	0	0	1	1	0	0	0
23	22	21	20	19	18	17	16
TRIGGER_TIME_L							
15	14	13	12	11	10	9	8
TRIGGER_TIME_L							
7	6	5	4	3	2	1	0
TRIGGER_TIME_L							

TRIGGER_TIME_L:

This is the lower 24bits of the trigger time

Word 2:

31	30	29	28	27	26	25	24
0	0	0	0	0	0	0	0
23	22	21	20	19	18	17	16
TRIGGER_TIME_H							
15	14	13	12	11	10	9	8
TRIGGER_TIME_H							
7	6	5	4	3	2	1	0
TRIGGER_TIME_H							

TRIGGER_TIME_H:

This is the upper 24bits of the trigger time

Data Type: HPS Cluster

Type: 0x4

Size: 2 words

Description: This data type identifies HPS ECAL clusters found in the level 1 trigger. This is intended to be used for trigger efficiency studies and verification.

Word 1:

31	30	29	28	27	26	25	24
1	0	1	0	0	CLUSTER_N		
23	22	21	20	19	18	17	16
CLUSTER_N		CLUSTER_E					
15	14	13	12	11	10	9	8
CLUSTER_E						CLUSTER_Y	
7	6	5	4	3	2	1	0
CLUSTER_Y			CLUSTER_X				

CLUSTER_X:

Cluster center X coordinate. This is a signed value that ranges from -22 to +23

CLUSTER_Y:

Cluster center Y coordinate. This is a signed value that ranges from -5 to +5

CLUSTER_E:

Cluster energy in MeV units. This is an unsigned value that ranges from 0 to 8191

CLUSTER_N:

Number of hits found in cluster. This is an unsigned value that ranges from 0 to 9

Word 2:

31	30	29	28	27	26	25	24
0	0	0	0	0	0	0	0
23	22	21	20	19	18	17	16
0	0	0	0	0	0	0	0
15	14	13	12	11	10	9	8
0	0	0	0	0	0	CLUSTER_T	
7	6	5	4	3	2	1	0
CLUSTER_T							

CLUSTER_T:

Time in 4ns ticks measured from beginning of trigger window that cluster is found.

Data Type: HPS Trigger

Type: 0x5

Size: 1 word

Description: This data type identifies HPS ECAL triggers that were found.

Word 1:

31	30	29	28	27	26	25	24
1	0	1	0	1	TYPE		
23	22	21	20	19	18	17	16
TYPE	DATA						
15	14	13	12	11	10	9	8
0	0	0	0	0	0	TIME	
7	6	5	4	3	2	1	0
TIME							

TYPE:

Trigger type that matches one of the following:

0	Cosmic trigger from top crate
1	Cosmic trigger from bottom crate
2	Cluster singles trigger 0 from top crate
3	Cluster singles trigger 0 from bottom crate
4	Cluster singles trigger 1 from top crate
5	Cluster singles trigger 1 from bottom crate
6	Cluster pair trigger 0
7	Cluster pair trigger 1

DATA:

This data field is specific to the TYPE field and indicates various pass/fail tests:

Cosmic trigger (type 0,1):

DATA(6..0) will be "0000000"

Cluster singles trigger (type 2-5):

DATA(0): 1/0 – pass/fail cluster "E MIN" cut.

DATA(1): 1/0 – pass/fail cluster "E MAX" cut.

DATA(2): 1/0 – pass/fail cluster "N HITS MIN" cut.

Cluster pair trigger (type 6-7):

DATA(0): 1/0 – pass/fail pair "SUM" cut

DATA(1): 1/0 – pass/fail pair "DIFFERENCE" cut

DATA(2): 1/0 – pass/fail pair "ENERGY SLOPE" cut

DATA(3): 1/0 – pass/fail pair "COPLANAR" cut

TIME:

Time in 4ns ticks measured from beginning of trigger window that trigger condition was found.

Data Type: Data Not Valid

Type: 0x14

Size: 1 word

Description: Module has no data available for readout. This can if the module is being read out too quickly after receiving (event building is in process and no data words have been put into the buffer yet) a trigger or if the module doesn't have any events to report.

31	30	29	28	27	26	25	24
1	1	1	1	0	UNDEFINED		
23	22	21	20	19	18	17	16
UNDEFINED							
15	14	13	12	11	10	9	8
UNDEFINED							
7	6	5	4	3	2	1	0
UNDEFINED							

Data Type: Filler Word

Type: 0x15

Size: 1 word

Description: Non-data word appended to the block of events. This is used to force the total number of 32-bit words read out of a module to be a multiple of 2 or 4 when

31	30	29	28	27	26	25	24
1	1	1	1	1	UNDEFINED		
23	22	21	20	19	18	17	16
UNDEFINED							
15	14	13	12	11	10	9	8
UNDEFINED							
7	6	5	4	3	2	1	0
UNDEFINED							

7. VME Registers

All SSP board registers can be accessed through the VME bus in the following mode:

- A24: single cycle accesses, 32bit aligned read or write access (register specific)

Event readout can be access through the VME bus in the following modes:

- A32: single cycle, BLT, MBLT, 2eVME, 2eSST

- Note: transfer rate for 2eSST is 200MB/s

-

Register Summary:

Register Name	Description	Address Offset
SspCfg peripheral (offset 0x0000)		
BoardId	Board identification	0x0000
FirmwareRev	Firmware revision	0x0004
SpiCtrl	Non-volatile flash control	0x0008
SpiStatus	Non-volatile flash status	0x000C
ICapCtrl	FPGA configuration interface	0x0010
ICapDataWr	FPGA configuration interface	0x0014
ICapDataRd	FPGA configuration interface	0x0018
ICapStatus	FPGA configuration interface	0x001C

Clk peripheral (offset 0x0100)		
Ctrl	Clock control	0x0000
Status	Clock status	0x0004

Sd peripheral (offset 0x0200)		
SrlSel[]	Signal muxing	0x0000
PulserPeriod	Pulser Period	0x0080
PulserLowCycles	Pulser low cycles	0x0084
PulserNPulses	Pulser pulse count	0x0088
PulserStart	Pulser start	0x008C
PulserDone	Pulser status	0x0090
ScalerLatch	Latch scalers	0x0100
Scalers[]	Scalers	0x0104

Trg peripheral (offset 0x0400)		
Ctrl	Trigger control	0x0000
SumHistThr	Sum histogram threshold	0x0014
SumHistWindow	Sum histogram integral window	0x0018
SumHistData	Sum histogram bin data	0x0024

Serdes peripheral (0x1000, 0x1100, 0x1200, 0x1300, 0x1400,0x1500,0x1600,0x1700,0x1800,0x1900)		
Ctrl	Control	0x0000
CtrlTile0	Tile 0 control	0x0004
CtrlTile1	Tile 1 control	0x0008
DrpCtrl	Drp control	0x000C
Status	Status	0x0010
DrpStatus	Drp status	0x0014
ErrTile0	Tile 0 rx bit errors	0x0018
ErrTile1	Tile 1 rx bit errors	0x001C
MonCtrl	Monitor control	0x0030
MonStatus	Monitor status	0x0034
MonMask[]	Monitor mask	0x0040
MonVal[]	Monitor match values	0x0060
MonThr[]	Monitor thresholds	0x0080
MonData[]	Monitor capture data	0x0090

7.1 SspCfg Peripheral Registers Section

Basic board information registers can be used to verify that this board is the SSP and check for the software revision, which should be checked for compatibility. Reprogramming the SSP firmware is also possible through these registers.

Register: BoardId

Address Offset: 0x0000
 Size: 32bits
 Reset State: 0x53535020

31	30	29	28	27	26	25	24
BOARD_ID							
23	22	21	20	19	18	17	16
BOARD_ID							
15	14	13	12	11	10	9	8
BOARD_ID							
7	6	5	4	3	2	1	0
BOARD_ID							

BOARD_ID (RO):

0x53535020 = “SSP” in ASCII

Register: FirmwareRev

Address Offset: 0x0004
 Size: 32bits
 Reset State: 0xFFFFFFFF

31	30	29	28	27	26	25	24	
-	-	-	SLOTID					
23	22	21	20	19	18	17	16	
TEST	SSPTYPE							
15	14	13	12	11	10	9	8	
FIRMWARE_REV_MAJOR								
7	6	5	4	3	2	1	0	
FIRMWARE_REV_MINOR								

SLOTID(RO):

VME slot id

TEST(RO):

‘1’ indicates this firmware version is a test release. There can be many releases with this same version when this flag is set.

‘0’ indicates this firmware version is a controlled release. “There can be only one”

SSPTYPE(RO):

Firmware build type [0x00 to 0x7F]

Defined types:

0x01 HallID

FIRMWARE_REV_MAJOR (RO):

Major firmware revision number

FIRMWARE_REV_MINOR (RO):

Minor firmware revision number

Register: SpiCtrl

Address Offset: 0x0008

Size: 32bits

Reset State: 0x00000080

31	30	29	28	27	26	25	24
-	-	-	-	-	-	-	-
23	22	21	20	19	18	17	16
-	-	-	-	-	-	-	-
15	14	13	12	11	10	9	8
-	-	-	-	-	START	NCS_CLR	NCS_SET
7	6	5	4	3	2	1	0
TX_DATA							

TX_DATA (RW):

SPI tx data

NCS_SET (WO):

Sets the NCS line of the SPI flash memory

NCS_CLEAR (WO):

Clears the NCS line of the SPI flash memory

START (WO):

Begins a SPI transfer. Check SpiStatus DONE bit to determine when transaction is finished.

Notes:

- 1) This interface is used for firmware updates and general non-volatile parameter storage.

Register: SpiStatus

Address Offset: 0x000C

Size: 32bits

Reset State: 0xFFFFFFFF

31	30	29	28	27	26	25	24
-	-	-	-	-	-	-	-
23	22	21	20	19	18	17	16
-	-	-	-	-	-	-	-
15	14	13	12	11	10	9	8
-	-	-	-	DONE	-	-	-
7	6	5	4	3	2	1	0
RX_DATA							

RX_DATA (RO):

SPI rx data

DONE (RO):

'0' - SPI transfer in progress

'1' - SPI transfer is complete

Register: ICap

Address Offset: 0x0010
Size: 32bits
Reset State: 0xFFFFFFFF

Notes:

- 1) This interface provides direct access to the FPGA configuration interface. Only intended use is for a VME based FPGA reload after new firmware has been programmed into flash memory.

Register: ICapDataWr

Address Offset: 0x0014
Size: 32bits
Reset State: 0x00000000

Notes:

- 1) This interface provides direct access to the FPGA configuration interface. Only intended use is for a VME based FPGA reload after new firmware has been programmed into flash memory.

Register: ICapDataRd

Address Offset: 0x0018
Size: 32bits
Reset State: 0xFFFFFFFF

Notes:

- 1) This interface provides direct access to the FPGA configuration interface. Only intended use is for a VME based FPGA reload after new firmware has been programmed into flash memory.

Register: ICapStatus

Address Offset: 0x001C
Size: 32bits
Reset State: 0xFFFFFFFF

Notes:

- 1) This interface provides direct access to the FPGA configuration interface. Only intended use is for a VME based FPGA reload after new firmware has been programmed into flash memory.

7.2 Clk Peripheral Registers Section

Clock selection, reset, and status can be access through the following registers.

Register: Ctrl

Address Offset: 0x0000

Size: 32bits

Reset State: 0x00000000

31	30	29	28	27	26	25	24	
CLKRST	-	-	-	CLK_LOGIC		CLK_SERDES		
23	22	21	20	19	18	17	16	
-	DRP_DEN	DRP_WE	DRP_ADDR					
15	14	13	12	11	10	9	8	
DRP_DI								
7	6	5	4	3	2	1	0	
DRP_DI								

DRP_DI (RW):

DRP data input.

DRP_ADDR (RW):

DRP data address.

DRP_WE (RW):

DRP data write enable.

DRP_DEN (RW):

DRP data enable.

CLK_SERDES (RW):

Clock mux input selection:

“00” – disabled clock

“01” – VXS SWB SD clock

“10” – P2 clock

“11” – local clock

CLK_LOGIC (RW):

Clock mux input selection:

“00” – disabled clock

“01” – VXS SWB SD clock

“10” – P2 clock

“11” – local clock

CLKRST (RW):

Write ‘1’ to this bit to reset clock PLL whenever clock source is changed (either due to register changes to signal loss). Write ‘0’ to release reset once input clock source is stable.

Register: Status

Address Offset: 0x0004

Size: 32bits

Reset State: 0x00000000

31	30	29	28	27	26	25	24
-	-	-	-	-	-	-	-
23	22	21	20	19	18	17	16
-	-	-	-	-	-	LOCKED	DRP_RDY
15	14	13	12	11	10	9	8
DRP_DO							
7	6	5	4	3	2	1	0
DRP_DO							

DRP_DO (RO):

DRP data output.

DRP_RDY (RO):

'1' – DRP_DO is valid

'0' – DRP_DO invalid

LOCKED (RO):

'1' – SSP Global clock PLL is locked

'0' – SSP Global clock PLL not locked

7.3 Sd Peripheral Registers Section

Pulser setup and trigger, sync, general purpose I/O muxing are setup through the the following registers.

Register: SrcSel[]

Address Offset: 0x0000 + 4*SD_SRC_x

Size: 32bits

Reset State: 0x00000000

31	30	29	28	27	26	25	24	
-	-	-	-	-	-	-	-	
23	22	21	20	19	18	17	16	
-	-	-	-	-	-	-	-	
15	14	13	12	11	10	9	8	
-	-	-	-	-	-	-	-	
7	6	5	4	3	2	1	0	
-	-	-	SRC					

SRC (RW):

Selects the signal source for the output signal (output signal is indicated by the index into SrcSel[])

The SD_SRC_x ID map is used to determine which index in the SrcSel register array to use:

SD_SRC_x ID NAME	Index in SrcSel	Description
SD_SRC_LVDSOUT0	0	Front Panel LVDS/ECL output #0
SD_SRC_LVDSOUT1	1	Front Panel LVDS/ECL output #1
SD_SRC_LVDSOUT2	2	Front Panel LVDS/ECL output #2
SD_SRC_LVDSOUT3	3	Front Panel LVDS/ECL output #3
SD_SRC_LVDSOUT4	4	Front Panel LVDS/ECL output #4
SD_SRC_GPIO0	5	Front Panel NIM output #0
SD_SRC_GPIO1	6	Front Panel NIM output #1
SD_SRC_P2_LVDSOUT0	7	P2 LVDS output#0
SD_SRC_P2_LVDSOUT1	8	P2 LVDS output#1
SD_SRC_P2_LVDSOUT2	9	P2 LVDS output#2
SD_SRC_P2_LVDSOUT3	10	P2 LVDS output#3
SD_SRC_P2_LVDSOUT4	11	P2 LVDS output#4
SD_SRC_P2_LVDSOUT5	12	P2 LVDS output#5
SD_SRC_P2_LVDSOUT6	13	P2 LVDS output#6
SD_SRC_P2_LVDSOUT7	14	P2 LVDS output#7
SD_SRC_TRIG	15	SSP internal trigger
SD_SRC_SYNC	16	SSP internal sync

Possible values for SRC contents of register:

SD_SRC_SEL_x	Value	Source Signal Description
SD_SRC_SEL_0	0	Drive constant '0'
SD_SRC_SEL_1	1	Drive constant '1'
SD_SRC_SEL_SYNC	2	VXS SWB Sync
SD_SRC_SEL_TRIG1	3	VXS SWB Trig1
SD_SRC_SEL_TRIG2	4	VXS SWB Trig2
SD_SRC_SEL_LVDSIN0	5	Front panel LVDS input#0
SD_SRC_SEL_LVDSIN1	6	Front panel LVDS input#1
SD_SRC_SEL_LVDSIN2	7	Front panel LVDS input#2
SD_SRC_SEL_LVDSIN3	8	Front panel LVDS input#3
SD_SRC_SEL_LVDSIN4	9	Front panel LVDS input#4
SD_SRC_SEL_P2LVDSIN0	10	P2 LVDS input#0
SD_SRC_SEL_P2LVDSIN1	11	P2 LVDS input#1
SD_SRC_SEL_P2LVDSIN2	12	P2 LVDS input#2
SD_SRC_SEL_P2LVDSIN3	13	P2 LVDS input#3
SD_SRC_SEL_P2LVDSIN4	14	P2 LVDS input#4
SD_SRC_SEL_P2LVDSIN5	15	P2 LVDS input#5
SD_SRC_SEL_P2LVDSIN6	16	P2 LVDS input#6
SD_SRC_SEL_P2LVDSIN7	17	P2 LVDS input#7
SD_SRC_SEL_PULSER	18	Pulser output
SD_SRC_SEL_BUSY	19	Event builder busy
SD_SRC_SEL_TRIGGER0	20	SSP firmware specific trigger signal#0
SD_SRC_SEL_TRIGGER1	21	SSP firmware specific trigger signal#1
SD_SRC_SEL_TRIGGER2	22	SSP firmware specific trigger signal#2
SD_SRC_SEL_TRIGGER3	23	SSP firmware specific trigger signal#3
SD_SRC_SEL_TRIGGER4	24	SSP firmware specific trigger signal#4
SD_SRC_SEL_TRIGGER5	25	SSP firmware specific trigger signal#5
SD_SRC_SEL_TRIGGER6	26	SSP firmware specific trigger signal#6
SD_SRC_SEL_TRIGGER7	27	SSP firmware specific trigger signal#7

Register: PulserPeriod

Address Offset: 0x0080
 Size: 32bits
 Reset State: 0x00000000

31	30	29	28	27	26	25	24
PERIOD							
23	22	21	20	19	18	17	16
PERIOD							
15	14	13	12	11	10	9	8
PERIOD							
7	6	5	4	3	2	1	0
PERIOD							

PERIOD (R/W):

Defines number of 4ns ticks for the pulser period

Register: PulserLowCycles

Address Offset: 0x0084
 Size: 32bits
 Reset State: 0x00000000

31	30	29	28	27	26	25	24
LOW_CYCLES							
23	22	21	20	19	18	17	16
LOW_CYCLES							
15	14	13	12	11	10	9	8
LOW_CYCLES							
7	6	5	4	3	2	1	0
LOW_CYCLES							

LOW_CYCLES (R/W):

Defines number of 4ns ticks of the pulser period the output stays low.

Register: PulserNPulses

Address Offset: 0x0088
 Size: 32bits
 Reset State: 0x00000000

31	30	29	28	27	26	25	24
COUNT							
23	22	21	20	19	18	17	16
COUNT							
15	14	13	12	11	10	9	8
COUNT							
7	6	5	4	3	2	1	0
COUNT							

COUNT (R/W):

0x00000000: disable pulser output
 0x00000001 to 0xFFFFFFFF: number of periods to deliver pulser output
 0xFFFFFFFF: infinite cycle count for pulser output

Notes:

- 1) When using fixed count of pulses the pulser must be trigger to start by writing to the **PulserStart** register

Register: PulserStart

Address Offset: 0x008C
 Size: 32bits
 Reset State: 0x00000000

31	30	29	28	27	26	25	24
PULSER_START							
23	22	21	20	19	18	17	16
PULSER_START							
15	14	13	12	11	10	9	8
PULSER_START							
7	6	5	4	3	2	1	0
PULSER_START							

PULSER_START (WO):

Write any value to start pulser operation. The pulse number counter is cleared.

Register: PulserDone

Address Offset: 0x0090
 Size: 32bits
 Reset State: 0x00000000

31	30	29	28	27	26	25	24
-	-	-	-	-	-	-	-
23	22	21	20	19	18	17	16
-	-	-	-	-	-	-	-
15	14	13	12	11	10	9	8
-	-	-	-	-	-	-	-
7	6	5	4	3	2	1	0
-	-	-	-	-	-	-	DONE

DONE (RO):

'0' – pulser is still delivering pulses as defined in **PulserNPulses**
 '1' – pulser is is not active (either disabled or has finished fixed pulse count)

Register: ScalerLatch

Address Offset: 0x0100
 Size: 32bits
 Reset State: 0x00000000

31	30	29	28	27	26	25	24
-	-	-	-	-	-	-	-
23	22	21	20	19	18	17	16
-	-	-	-	-	-	-	-
15	14	13	12	11	10	9	8
-	-	-	-	-	-	-	-
7	6	5	4	3	2	1	0
-	-	-	-	-	-	-	DISABLE

DISABLE (RW):

'1' – disables non-buffered scalers. Do this prior to reading out scalers
 '0' – enables non-buffered scalers. Do this after readout is complete. This will also reset the scaler contents to 0.

Register: Scalers[]

Address Offset: 0x0104
 Size: 32bits
 Reset State: 0x00000000

31	30	29	28	27	26	25	24
SCALER							
23	22	21	20	19	18	17	16
SCALER							
15	14	13	12	11	10	9	8
SCALER							
7	6	5	4	3	2	1	0
SCALER							

SCALER (RO):

32bit scaler value. Refer to map index to determine what signal is mapped to which offset in **Scalars[]**. Scalers will stop counting once 0xFFFFFFFF is reached – this value can be considered an indicator of overflow.

Scaler Name	Index in Scalers[]	Description
SD_SCALER_SYSCLK	0	50MHz counts since latch latch. Use for Reference.
SD_SCALER_GCLK	1	250MHz global clock. May not always be on.
SD_SCALER_SYNC	2	VXS SWB Sync input edges
SD_SCALER_TRIG1	3	VXS SWB Trig1 input edges
SD_SCALER_TRIG2	4	VXS SWB Trig2 input edges
SD_SCALER_GPIO0	5	FP NIM output#0 edges
SD_SCALER_GPIO1	6	FP NIM output#1 edges
SD_SCALER_LVDSIN0	7	FP LVDS input#0 edges
SD_SCALER_LVDSIN1	8	FP LVDS input#1 edges
SD_SCALER_LVDSIN2	9	FP LVDS input#2 edges
SD_SCALER_LVDSIN3	10	FP LVDS input#3 edges
SD_SCALER_LVDSIN4	11	FP LVDS input#4 edges
SD_SCALER_LVDSOUT0	12	FP LVDS output#0 edges
SD_SCALER_LVDSOUT1	13	FP LVDS output#1 edges
SD_SCALER_LVDSOUT2	14	FP LVDS output#2 edges
SD_SCALER_LVDSOUT3	15	FP LVDS output#3 edges
SD_SCALER_LVDSOUT4	16	FP LVDS output#4 edges
SD_SCALER_BUSY	17	Busy assertion edges seen
SD_SCALER_BUSYCYCLES	18	Number of 50MHz cycles busy was high
SD_SCALER_P2_LVDSIN0	19	P2 LVDS input#0 edges
SD_SCALER_P2_LVDSIN1	20	P2 LVDS input#1 edges
SD_SCALER_P2_LVDSIN2	21	P2 LVDS input#2 edges
SD_SCALER_P2_LVDSIN3	22	P2 LVDS input#3 edges
SD_SCALER_P2_LVDSIN4	23	P2 LVDS input#4 edges
SD_SCALER_P2_LVDSIN5	24	P2 LVDS input#5 edges
SD_SCALER_P2_LVDSIN6	25	P2 LVDS input#6 edges
SD_SCALER_P2_LVDSIN7	26	P2 LVDS input#7 edges
SD_SCALER_P2_LVDSOUT0	27	P2 LVDS output#0 edges
SD_SCALER_P2_LVDSOUT1	28	P2 LVDS output#1 edges
SD_SCALER_P2_LVDSOUT2	29	P2 LVDS output#2 edges
SD_SCALER_P2_LVDSOUT3	30	P2 LVDS output#3 edges
SD_SCALER_P2_LVDSOUT4	31	P2 LVDS output#4 edges
SD_SCALER_P2_LVDSOUT5	32	P2 LVDS output#5 edges
SD_SCALER_P2_LVDSOUT6	33	P2 LVDS output#6 edges
SD_SCALER_P2_LVDSOUT7	34	P2 LVDS output#7 edges

7.4 Trg Peripheral Registers Section

The following registers setup the trigger processing of the SSP.

Register: Ctrl

Address Offset: 0x0000

Size: 32bits

Reset State: 0x00000000

31	30	29	28	27	26	25	24
-	-	-	-	-	-	-	-
23	22	21	20	19	18	17	16
-	-	-	-	-	-	-	-
15	14	13	12	11	10	9	8
GTP_SRC							
7	6	5	4	3	2	1	0
FIBER_EN							

FIBER_EN (R/W):

Bit x:

'1' enabled fiber port x in trigger processor.

'0' disables fiber port x in trigger processor.

GTP_SRC (R/W):

Determines the trigger data sent to the GTP over the VXS backplane:

0 – Fiber port 0 data

1 – Fiber port 1 data

2 – Fiber port 2 data

3 – Fiber port 3 data

4 – Fiber port 4 data

5 – Fiber port 5 data

6 – Fiber port 6 data

7 – Fiber port 7 data

8 – Sum of all fiber ports enabled by FIBER_EN bits

Register: SumHistThr

Address Offset: 0x0014
 Size: 32bits
 Reset State: 0x00000000

31	30	29	28	27	26	25	24
THR							
23	22	21	20	19	18	17	16
THR							
15	14	13	12	11	10	9	8
THR							
7	6	5	4	3	2	1	0
THR							

THE (R/W):

Threshold applied to Sum trigger data. When Sum trigger data go above this threshold the histogrammer will integrate a window (defined by SumHistWindow) and increment the bin corresponding to this integral value.

Register: SumHistWindow

Address Offset: 0x0018
 Size: 32bits
 Reset State: 0x00000000

31	30	29	28	27	26	25	24
-	-	-	-	-	-	-	-
23	22	21	20	19	18	17	16
NSA							
15	14	13	12	11	10	9	8
-	-	-	-	-	-	-	-
7	6	5	4	3	2	1	0
NSB							

NSA(R/W):

The number of samples to integrate the Sum trigger data after it crosses threshold

NSB(R/W):

The number of samples to integrate the Sum trigger data before it crosses threshold

Register: SumHistData

Address Offset: 0x0024
 Size: 32bits
 Reset State: 0x00000000

31	30	29	28	27	26	25	24
DATA							
23	22	21	20	19	18	17	16
DATA							
15	14	13	12	11	10	9	8
DATA							
7	6	5	4	3	2	1	0
DATA							

DATA(R/O):

Read this register 32 times after the histogram has been disabled. The 1st data corresponds to bin 0, the 512th read corresponds to bin 31. The bins are scaled \log_2 to maintain a large dynamic range over the range of pulse energy than may be obtained.

7.5 Serdes Peripheral Registers Section

The following registers setup/monitor each of the Serdes (Fiber and VXS) of the SSP.

Register: Ctrl

Address Offset: 0x0000
 Size: 32bits
 Reset State: 0x00000203

31	30	29	28	27	26	25	24
-	-	-	-	-	-	-	-
23	22	21	20	19	18	17	16
-	-	-	-	-	-	-	-
15	14	13	12	11	10	9	8
-	-	-	-	ERR_EN	ERR_RST	RESET	TXENPRBS
7	6	5	4	3	2	1	0
TXENPRBS	RXENPRBS		LOOPBACK			GTRESET	PWRDN

PWRDN (R/W):

- '1' disable power of the transceiver
- '0' enable power of the transceiver

GTRESET (R/W):

- '1' reset transceiver
- '0' release reset of transceiver

LOOPBACK (R/W):

- "000" – keep at this value

RXENPRBS (R/W):

- "00" – keep at this value

TXENPRBS (R/W):

- "00" – keep at this value

RESET (R/W):

- '1' reset link
- '0' release reset of link

ERR_RST (R/W):

- '1' reset error counts
- '0' release reset error counts

ERR_EN (R/W):

- '1' enable error counts
- '0' disable error counts (error counters should be disabled when read)

Register: CtrlTile0

Address Offset: 0x0004
 Size: 32bits
 Reset State: 0x05420542

31	30	29	28	27	26	25	24
-	-	-	-	TXDIFFCTRL1		TXBUFDIFFCTRL1	
23	22	21	20	19	18	17	16
TXBUFDIFFCTRL1		TXPREEMPHASIS1				RXEQMIX1	
15	14	13	12	11	10	9	8
-	-	-	-	TXDIFFCTRL0		TXBUFDIFFCTRL0	
7	6	5	4	3	2	1	0
TXBUFDIFFCTRL0		TXPREEMPHASIS0				RXEQMIX0	

Do not modify values on this register.

Register: CtrlTile1

Address Offset: 0x0008
 Size: 32bits
 Reset State: 0x05420542

31	30	29	28	27	26	25	24
-	-	-	-	TXDIFFCTRL1		TXBUFDIFFCTRL1	
23	22	21	20	19	18	17	16
TXBUFDIFFCTRL1		TXPREEMPHASIS1				RXEQMIX1	
15	14	13	12	11	10	9	8
-	-	-	-	TXDIFFCTRL0		TXBUFDIFFCTRL0	
7	6	5	4	3	2	1	0
TXBUFDIFFCTRL0		TXPREEMPHASIS0				RXEQMIX0	

Do not modify values on this register.

Register: DrpCtrl

Address Offset: 0x000C
 Size: 32bits
 Reset State: 0x00000000

31	30	29	28	27	26	25	24
-	-	-	-		DEN_TILE1	DEN_TILE0	DWE
23	22	21	20	19	18	17	16
-	DRP_ADDR						
15	14	13	12	11	10	9	8
DRP_DIN							
7	6	5	4	3	2	1	0
DRP_DIN							

Do not modify values on this register.

Register: Status

Address Offset: 0x0010

Size: 32bits

Reset State: 0x00000000

31	30	29	28	27	26	25	24
-	-	-	-	-	-	-	-
23	22	21	20	19	18	17	16
-							
15	14	13	12	11	10	9	8
	SRCRDYN	TXLOCK	CHUP	RXPOL3	RXPOL2	RXPOL1	RXPOL0
7	6	5	4	3	2	1	0
LANEUP3	LANEUP2	LANEUP1	LANEUP0	HARDERR3	HARDERR2	HARDERR1	HARDERR0

HARDERRx (RO):

'0' – no hard error on lane x

'1' – hard error occurred on lane x. Reset is required.

LANEUPx (RO):

'0' – lane x is down.

'1' – lane x is up

RXPOLx (RO):

'0' – rx polarity is normal

'1' – rx polarity is inverted

CHUP (RO):

'0' – channel is down

'1' – channel is up

TXLOCK (RO):

'0' – TX PLL not locked (likely due to missing 250MHz global clock)

'1' – TX PLL is locked

SRCRDYN (RO):

'0' – Data is current being received over channel

'1' – Data is not being received over channel

Register: CrateId

Address Offset: 0x0020
 Size: 32bits
 Reset State: 0x00000000

31	30	29	28	27	26	25	24
-	-	-	-	-	-	-	-
23	22	21	20	19	18	17	16
-	-	-	-	-	-	-	-
15	14	13	12	11	10	9	8
CRATEID							
7	6	5	4	3	2	1	0
CRATEID							

CRATEID (RO):

The first lower 16bit word received on the transceiver which has been defined to be the CrateId. This is updated any time the link goes from ILDE->DATA (normally only when the system SYNC goes low)

Register: MonCtrl

Address Offset: 0x0030
 Size: 32bits
 Reset State: 0x00000000

31	30	29	28	27	26	25	24
-	-	-	-	-	-	-	-
23	22	21	20	19	18	17	16
-	-	-	-	-	-	-	-
15	14	13	12	11	10	9	8
-	-	-	-	-	-	-	-
7	6	5	4	3	2	1	0
-	-	-	-	-	-	-	ID_RESET

ID_RESET (RW):

'0' – does nothing
 '1' – resets CrateId to 0 (this is an auto-clearing bit)

Register: MonStatus

Address Offset: 0x0034
 Size: 32bits
 Reset State: 0x00000000

31	30	29	28	27	26	25	24
LATENCY							
23	22	21	20	19	18	17	16
LATENCY							
15	14	13	12	11	10	9	8
-	-	-	-	CRCOK3	CRCOK2	CRCOK1	CRCOK0
7	6	5	4	3	2	1	0
-	-	-	-	-	-	-	RDY

RDY (RO):

'0' – serdes data monitor has not triggered
 '1' – serdes data monitor has triggered and data is ready for readout

CRCx (RO):

'0' – lane x has failed CRC verification during last sync frame
 '1' – lane x has passed CRC verification during last sync frame

LATENCY (RO):

Latency, in 4ns ticks, from SYNC to receipt of first trigger word on serdes

Register: MonMask

Address Offset: 0x0040,...
Size: 32bits
Reset State: 0x00000000

Used for debugging.

Register: MonVal

Address Offset: 0x0060,...
Size: 32bits
Reset State: 0x00000000

Used for debugging.

Register: MonThr

Address Offset: 0x0080,...
Size: 32bits
Reset State: 0x00000000

Used for debugging.

Register: MonData

Address Offset: 0x0090,...
Size: 32bits
Reset State: 0x00000000

Used for debugging.

Appendix A: Alternate use – front-end readout mode

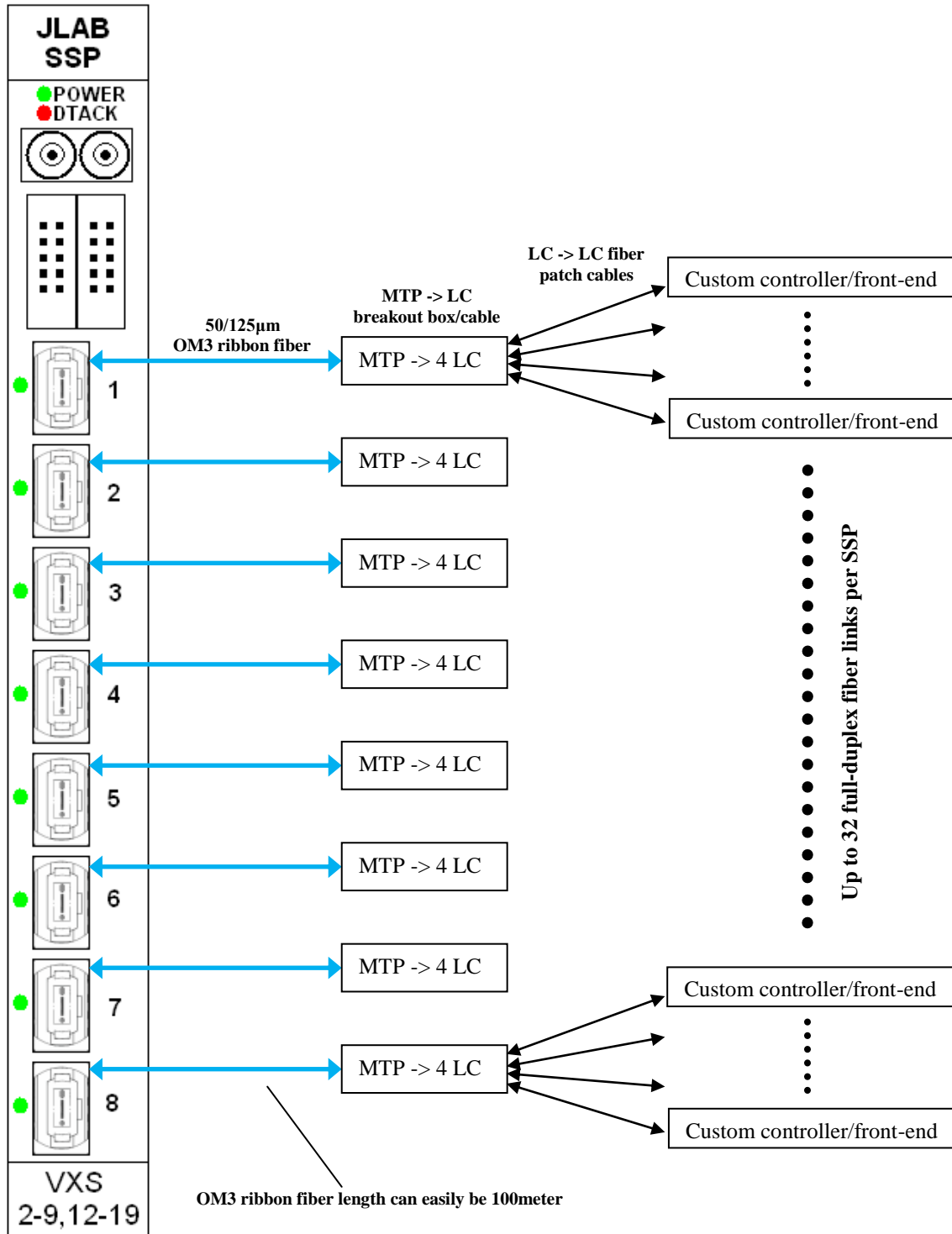

General Notes:

- 1) SSP has 32 full-duplex fiber links that can operate at up to 6.25Gbps. These could be partitioned in a few different ways. Shown above would allow each SSP to connect to 32 different controllers; however, if higher bandwidth is needed it may make more sense to deliver the full MTP connection to each controller (in which case only 8 controllers per SSP would be supported, but at >20Gbps per controller).
- 2) Listed lines rates would be reduced to 80% for usable data transfer rates after 8b/10b encoding rules have been applied (to satisfy maximum run length/AC coupling requirements).
- 3) If the fiber optic links deliver enough bandwidth, all front-end data could be stream to the SSP where the readout data trigger matching, data suppression, and event building could be performed. This option would minimize the new hardware developments. Alternatively much of this work could be performed on the front-end boards and the fiber links would be for delivering trigger and synchronization signals in one direction, and triggered data and status in the other direction.
- 4) A synchronizing clock will likely be needed and could be derived from the SSP fiber links. This approach has a few potential problems for the front-end sampling:
 - a. Recovered SerDes clock will be jittery (on the order of 10's of ps RMS jitter). This can be reduced/filtered by a jitter cleaning PLL.
 - b. The recovered SerDes clock will have phase variations each time a link is established. This would result in a timing uncertainty of the recovered clock period, typically 6.4ns at 3.125Gbps (depending on the SerDes it could be a few times higher though). This can be reduced by with some tricks in a configurable SerDes to achieve sub-nanosecond stability, but requires firmware development and testing to quantify the achievable stability.

Document Revision History

8/15/2013 (V2.0 firmware):

- 1) Initial document released with Hall D firmware features implemented.

1/13/2014 (V2.1 firmware):

SD Peripheral:

- 1) Updated Pulser clock source to use the 250MHz global clock (as registers indicated, 50MHz local clock was incorrectly used before)
- 2) ScalerLatch changed to R/W. Must be set to enable scalers to count, disabled to stop scalers so they can be read. This includes histograms

Clk Peripheral:

- 1) Changed clock selection bits register Ctrl. These changes also provide readable values so clock source can be read back.

Cfg Peripheral

- 1) added ICapDataWr, ICapDataRd, ICapStatus registers for full FPGA ICAP primitive support to allow FPGA reconfiguration via VME registers.

Serdes Peripheral

- 1) In Serdes peripheral: added CrateId registers for fiber transceiver ports

Trg Peripheral

- 1) In Trigger peripheral: SumHistWindow NSA/NSB changed to 8bit values
- 2) Removed SumHistCtrl: histogram is now controlled by Sd->ScalerLatch
- 3) Removed SumHistTime: histogram is now controlled by Sd->ScalerLatch, so Sd clk scalers can be used for histogram normalization
- 4) SumHistData changed from 512bins to 32bins (bin 0 = 2^0 , bin 1 = 2^1 , ...bin 31 = 2^{31})

Cfg Peripheral

- 1) Changed FirmwareRev register to shrink SSPTYPE to 8bits and add the VME SLOTID.

2/14/2014 (V2.2 firmware):

Changed configuration clock from 35MHz to 20MHz nominal.

5/5/2014 (V1.4 firmware):

- 1) Note: firmware versions had bug where 1.0-1.2 were showing up as 2.0-2.2...
- 2) Fixed SPI interface access error that happened on first access.
- 3) Added test version flag to firmware revision register (SspCfg->FirmwareRev)
- 4) Added Ser[.].MonCtrl register to support reset of CrateId